

**HEX HEAT TREATED SCREWS
GRADE 5 ZINC PLATED OR BLACK FINISH
GRADE 8 ZINC PLATED HEAT TREATED COARSE HEX SCREWS**

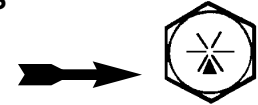

LOOK
for the Three Marks
on the Head for Grade 5
**SIZES LISTED BELOW
ARE IN STOCK**

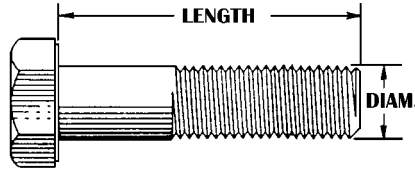

LOOK
for the Six Marks
on the Head for Grade 8
**USE GRADE 5 NUTS or
GRADE 8 NUTS FOR STRENGTH**

PRICE PER 100 PIECES

1/4" DIAMETER

5/16" DIAMETER

Length Inches	1/4" DIAMETER						5/16" DIAMETER							
	COARSE THREAD			FINE THREAD			COARSE THREAD			FINE THREAD				
	No. in Pkg.	Our Sequence Number	Grade 5 Zinc Plated Heat Treated Pkg.	Our Sequence Number	Grade 8 4140 Alloy Zinc Plated Heat Treated Pkg.	Our Sequence Number	Grade 8 4140 Alloy Zinc Plated Heat Treated Pkg.	No. in Pkg.	Our Sequence Number	Grade 5 Zinc Plated Heat Treated Pkg.	Our Sequence Number	Grade 8 4140 Alloy Zinc Plated Heat Treated Pkg.	Our Sequence Number	
1/2	100	033920	\$5.11*	069160	\$5.40*	073000	\$11.20	100	034624	\$7.60	069600	\$8.63	073030	\$14.34
3/4	100	033984	5.63*	069162	6.73*	073002	7.40	100	034688	7.22*	069602	9.83*	073032	24.19
1	100	034048	5.46*	069164	8.43*	073004	8.58	100	034752	8.32*	069604	11.28*	073034	14.30
1-1/4	100	034112	7.97	069166	7.53	073006	13.15	100	034816	9.88	069606	13.59	073036	45.99
1-1/2	100	034176	7.84*	069168	10.28*	073008	12.70	100	034880	11.42*	069608	15.92*	073038	19.71
1-3/4	100	034240	11.47	069169	12.88	073010	18.57	100	034912	15.82	069610	20.18	073040	33.11
2	100	034304	10.17*	069170	14.79*	073012	17.62	100	034944	14.99*	069612	20.70*	073042	24.52
2-1/4	100	034336	10.37	069171	50.09		100	034976	16.69	
2-1/2	100	034368	11.42	069172	17.64	073014	31.31	100	035008	17.51*	069614	24.78*	073044	26.40
2-3/4	100		069173	43.82	073016	22.30	100	035012	19.69	069615	27.41	073046	26.06
3	100	034432	13.39	069174	28.71	073018	28.33	100	035072	23.15	069616	29.12	073048	31.02
3-1/2	100	034496	24.38	069176	25.41	073020	44.15	50	035136	34.76	069668	38.22	073050	52.33
4	100	034560	24.35	069178	30.31	073022	51.92	50	035200	31.42	069670	40.40	073052	74.74
4-1/2	100	034565	35.52		50	035208	43.35	
5	100	034570	42.97		50	035212	52.82	069672	73.68	
5-1/2	100		069348	99.05		50	035220	59.64	
6	100	034580	52.13		50	035224	67.98	
7	5	034600	52.29+		5	035250	74.40+	
8	5	034602	59.21+		5	035252	76.38+	

SH14C5 1/4" Grade 5 Asst: 1 pkg. each starred size Sequence # Z90510
SH14C8 1/4" Grade 8 Asst: 1 pkg. each starred size Sequence # Z91736

SH516C5 5/16" Gr 5 Asst: 1 pkg. ea starred size Sequence # Z90520
SH516C8 5/16" Gr 8 Asst: 1 pkg. ea starred size Sequence # Z91744

3/8" DIAMETER

7/16" DIAMETER

Length Inches	3/8" DIAMETER						7/16" DIAMETER							
	COARSE THREAD			FINE THREAD			COARSE THREAD			FINE THREAD				
	No. in Pkg.	Our Sequence Number	Grade 5 Zinc Plated Heat Treated Pkg.	Our Sequence Number	Grade 8 4140 Alloy Zinc Plated Heat Treated Pkg.	Our Sequence Number	Grade 8 4140 Alloy Zinc Plated Heat Treated Pkg.	No. in Pkg.	Our Sequence Number	Grade 5 Zinc Plated Heat Treated Pkg.	Our Sequence Number	Grade 8 4140 Alloy Zinc Plated Heat Treated Pkg.	Our Sequence Number	
1/2	100	035260	\$13.15	069850	\$15.95	073060	\$18.86	--		\$....		\$....		
3/4	100	035264	11.80	069852	16.28	073062	31.35	--			
1	100	035328	12.05*	069854	15.25*	073064	19.54	100	036224	17.48*	070019	22.18*	073100	27.38
1-1/4	100	035392	14.04	069856	17.46	073066	20.58	50	036256	23.26	070020	24.45	073102	47.09
1-1/2	100	035456	16.43*	069858	17.89*	073068	25.47	50	036288	22.84*	070021	27.98*	073104	34.47
1-3/4	100	035520	21.91	069860	25.05	073070	44.22	50	036320	29.66	070022	31.24	073106	63.96
2	100	035584	20.94*	069862	29.90*	073072	32.79	50	036352	28.74*	070023	39.89*	073108	42.48
2-1/4	50	035616	26.95	069863	29.90	073074	37.86	--		073110	54.02
2-1/2	50	035648	25.46*	069864	32.09*	073076	39.59	50	036416	34.87*	070025	47.43*	073112	56.09
2-3/4	50	035652	26.31	069865	42.67	073078	43.93	50		070055	52.10	073114	70.42
3	50	035712	34.66*	069866	39.41*	073080	46.54	50	036480	41.00*	070027	64.30*	073116	65.41
3-1/2	50	035776	38.75	069868	51.92	073081	85.14	25	036544	55.46	070029	60.56	073118	111.57
4	50	035840	46.96	069870	51.50	073082	94.97	25	036608	62.77	070031	65.01	073120	149.45
4-1/2	50	035904	75.62	069871	93.20	073084	105.17	25	036672	99.84	070033	115.91	
5	50	035968	56.18	069872	92.05	073086	115.15	25	036736	78.77	
5-1/2	50	036032	65.02	069874	105.75	073088	123.32	25	036742	114.21	
6	50	036096	92.79	069876	101.72	073090	134.44	25	036757	124.39	
7	50	036100	103.89		--	
8	50	036102	121.39		--	
9	5	036120	121.39+		--	
10	5	036122	144.06+		--	

SH38C5 3/8" Gr 5 Asst: 1 pkg. each starred size Sequence # Z90530
SH38C8 3/8" Gr 8 Asst: 1 pkg. each starred size Sequence # Z91746

SH716C5 7/16" Gr 5 Asst: 1 pkg. ea starred size Sequence # Z90540
SH716C8 7/16" Gr 8 Asst: 1 pkg. ea starred size Sequence # Z91738

Qty. Disc: 5% for 5 pkgs., 7% for 10 pkgs., 10% for 25 pkgs.; 22.8% for 50 pkgs. Can mix sizes & types.

**BEST SELLER HEX SCREW, CARRIAGE SCREW, AND NUT ASSORTMENTS
IN STANDARD PACKAGES-PLATED**
These Assortments contain ONLY the BEST SELLERS



Large 1/2 inch high bold numbers on easy-to-read label on front of box can be read 5 feet away.

Each Assortment Contains	Our Sequence Number	Coarse Grade 5 Heat Treated Assort. No. & Per Each		Our Sequence Number	Coarse Grade 8 Alloy Heat Treated Assort. No. & Per Each		Our Sequence Number	Coarse Grade 2 Regular Assort. No. & Per Each		Our Sequence Number	Fine Grade 5 Heat Treated Assort. No. & Per Each		Our Sequence Number	Fine Grade 8 Alloy Heat Treated Assort. No. & Per Each		CARRIAGE SCREW	
		SH14C5	Z91736		SH14C8	SH516C5		Z91744	SH516C8		SH716C5	Z91738		SH716C8	SH12C5	Z90870	SH12C8
1/4" Assortment Has 500 pieces 100 pcs. each of 1/4x1/2, 1/4x3/4, 1/4x1, 1/4x1-1/2, 1/4x2; Carriage has 2-1/2 instead of 1/2	Z90510	SH14C5	Z91736	SH14C8	---	---	Z91710	SH14FF	Z91466	SC14C5	\$69.79						
5/16" Assortment Has 500 pieces 100 pcs. each of 5/16x3/4, 5/16x1, 5/16x1-1/2, 5/16x2, 5/16x2-1/2	Z90520	SH516C5	Z91744	SH516C8	---	---	Z91712	SH516FF	Z91468	SC516C5	\$73.68						
3/8" Assortment Has 400 pieces 100 pcs. each of 3/8x1, 3/8x1-1/2, 3/8x2; 50 each of 3/8x2-1/2, 3/8x3	Z90530	SH38C5	Z91746	SH38C8	---	---	Z91714	SH38FF	Z91470	SC38C5	\$104.98						
7/16" Assortment Has 300 pieces 100 pcs. each of 7/16x1; 50 each of 7/16x1-1/2, 7/16x2, 7/16x2-1/2, 7/16x3	Z90540	SH716C5	Z91738	SH716C8	---	---	Z91716	SH716FF	Z91472	SC716C5	\$100.36						
1/2" Assortment Has 250 pieces 50 pcs. each of 1/2x1, 1/2x1-1/2, 1/2x2, 1/2x2-1/2, 1/2x3	Z90550	SH12C5	Z90870	SH12C8	---	---	Z91718	SH12F8	Z91474	SC12C5	\$112.19						
9/16" Assortment Has 125 pieces 25 pcs. each of 9/16x1-1/2, 9/16x2, 9/16x2-1/2, 9/16x3, 9/16x4	---	---	Z91754	SH916C8	---	---	Z91720	SH916F8		---	---						
5/8" Assortment Has 125 pieces 25 pcs. each of 5/8x1-1/2, 5/8x2, 5/8x2-1/2, 5/8x3, 5/8x4; Grade 5 Carriage has no 1-1/2 and 4	Z90570	SH58C5	Z90880	SH58C8	---	---	Z91722	SH58F8	Z91476	SC58C5	\$70.83						
3/4" Assortment Has 100 pieces 20 pcs. each of 3/4x1-1/2, 3/4x2, 3/4x2-1/2, 3/4x3, 3/4x4	Z90580	SH34C5	Z90890	SH34C8	---	---	Z91724	SH34F8		---	---						
7/8" Assortment Has 75 pieces 15 pcs. each of 7/8x2, 7/8x2-1/2, 7/8x3, 7/8x3-1/2, 7/8x4; Grade 8 Fine has 2-1/4 instead of 2	Z90590	SH78C5	Z91680	SH78C8	---	---	Z91726	SH78F8		---	---						
1" Assortment Has 50 pieces 10 pcs. each of 1x2-1/2, 1x3, 1x4, 1x5, 1x6	Z90600	SH1C5	Z91682	SH1C8	---	---	Z91728	SH1F8		---	---						
Nut Assortment Has 495 pieces 100 pcs. each of 1/4, 5/16, 3/8; 50 each of 7/16, 1/2; 25 each of 9/16, 5/8; 20 each of 3/4; 15 each of 7/8; 10 each of 1	Z91690	SHCN5	Z90810	SHCN8	---	---	Z91709	SHFN5	Z91756	SHFN8	\$94.15						
Flatwasher Assortment Has 45 pounds 5 pounds each of 1/4, 5/16, 3/8, 7/16, 1/2 5/8, 3/4, 7/8, 1 Plated Flatwashers	---	---	---	---	---	---	Z91684	SFLAT2	---	---	---						
Flatwasher Assortment Has 45 pounds 5 pounds each of 1/4, 5/16, 3/8, and 10 pounds each of 1/2 5/8, 3/4 Plated Flatwashers	---	---	---	---	---	---	Z91484	TFLAT2	---	---	---						
Flatwasher Assortment Has 900 pieces 100 pcs. each of 1/4, 5/16, 3/8, 7/16, 1/2, 5/8, 3/4, 7/8, 1 Plated Flatwashers	Z91686	SFLAT5	Z91688	SFLAT8	---	---	Z91686	SFLAT5	Z91688	SFLAT8	\$228.81	Z91686	SFLAT5	\$282.84			
Lockwasher Assortment Has 900 pieces 100 pcs. each of 1/4, 5/16, 3/8, 7/16, 1/2, 5/8, 3/4, 7/8, 1 Plated Regular Spring Lockwashers in 100 piece packages	Z91478	SLOCK5	Z91480	SLOCK8	---	---	Z91478	SLOCK5	Z91480	SLOCK8	\$196.89						
Elastic Stop Nut Assortment 790ESN contains 100 pcs. each of 1/4-20, 5/16-18, 3/8-16; 50 pcs. each of 1/2-13; 25 pcs. each of 5/8-11; 20 pcs. each of 3/4-10 in both Coarse & Fine threads. Has 790 pieces 393ESNC contains 100 pcs. each of 1/4-20, 5/16-18, 3/8-16; 50 pcs. each of 7/16-14, 1/2-13; 25 pcs. each of 9/16-12, 5/8-11; 20 pcs. each of 3/4-10; 15 pcs. each of 7/8-9; 10 pcs each of 1-8 Coarse Elastic Stop Nuts. Has 495 pieces 394ESNF contains same quantities as 393ESNC only in Fine Elastic Stop Nuts. Has 495 pieces	Z91217	393ESNC	---	---	Z91215	790ESN	Z91219	394ESNF	---	---	---	Z91217	393ESNC	\$155.25			
Ovalok Nut Assortment 790OVN contains 100 pcs. each of 1/4-20, 5/16-18, 3/8-16; 50 pcs. each of 1/2-13; 25 pcs. each of 5/8-11; 20 pcs. each of 3/4-10 in both Coarse & Fine threads. Has 790 pieces 395LNC contains 100 pcs. each of 1/4-20, 5/16-18, 3/8-16; 50 pcs. each of 7/16-14, 1/2-13; 25 pcs. each of 9/16-12, 5/8-11; 20 pcs. each of 3/4-10; 15 pcs. each of 7/8-9; 10 pcs each of 1-8 Coarse Ovalok Nuts. Has 495 pieces 394LNF contains same quantities as 393LNC only in Fine Ovalok Nuts. Has 495 pieces	Z91222	395LNC	---	---	Z91220	790OVN	Z91224	396LNF	---	---	---	Z91222	395LNC	\$113.10			
Best Seller Carriage Screw Assortment in Standard Packages Has 1375 pieces 100 pcs. each of 1/4x1, 1/4x1-1/2, 1/4x2, 1/4x2-1/2, 5/16x1, 5/16x1-1/2, 5/16x2, 5/16x2-1/2, 3/8x1, 3/8x1-1/2, 3/8x2 50 pcs. each of 3/8x2-1/2, 7/16x1-1/2, 7/16x2, 1/2x1-1/2, 1/2x2; 25 pcs. each of 5/8x2 Plated Carriage Screws.	---	---	---	---	---	---	---	---	---	---	---	Z91488	TCAR5	\$278.80			

NO. 3 HEAD PLOW SCREWS-SCRAPER BLADE SCREWS FLATHEAD - DOMEHEAD - CLIPPED HEAD For Bulldozer and Grader Blades

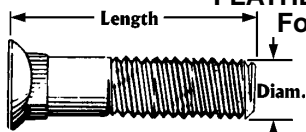

**USE GRADE 5
NUTS FOR STRENGTH**

No. 3 Round Head Square Neck - 82 Degrees Countersink
AISI 1035 (SAE Grade 5) High Tensile Steel
GRADE 5 ZINC PLATED and BLACKFLATHEAD PLOW SCREW
COARSE THREAD

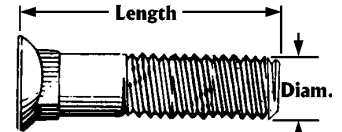

**USE GRADE 5
NUTS FOR STRENGTH**

3/8 Grade 5 Plow Screws					7/16 Grade 5 Plow Screws				1/2 Grade 5 Plow Screws				5/8 Grade 5 Plow Screws			
Length Inches	Fkg. Qty.	Plated Sequence Number	Black Sequence Number	Std. Pkg. Per 100	Pkg. Qty.	Plated Sequence Number	Black Sequence Number	Std. Pkg. Per 100	Pkg. Qty.	Plated Sequence Number	Black Sequence Number	Std. Pkg. Per 100	Pkg. Qty.	Plated Sequence Number	Black Sequence Number	Std. Pkg. Per 100
		PSC5PS	PSC5PS			PSC5PS	PSC5PS			PSC5PS	PSC5PS			PSC5PS	PSC5PS	
1	100	----	059969	\$15.40	--	----		\$....	--	----		\$....	--	----		\$....
1-1/4	100	----	060033	19.92	50	----	060226	22.38	--	----		--	----	
1-1/2	100	----	0600962	21.28	50	----	060289	28.29	50	----	060609	37.31	--	----	
1-3/4	100	----	0600974	24.71	50	----	060353	30.92	--	----		--	----	
2	100	----	0600982	27.89	50	----	060418	35.26	50	----	060674	48.17	25	----	060865	84.19
2-1/4	--	----	----	50	----	060482	46.79	50	060676	060678	65.14	--	----	
2-1/2	50	060100	060102	33.84	50	----	0605441	42.85	50	----	060737	60.97	25	----	060929	100.62
2-3/4	--	----	----	50	060545	----	35.09	--	----		--	----	
3	--	----	----	50	----	060558	46.73	50	----	060739	89.96	25	----	060993	117.31
3-1/2	--	----	----	--	----	----	--	----		25	----	060995	128.10
Length of Thread, Inches		1-1/8			1-1/8				1-1/4				1-1/2			

GRADE 8 DOMEHEAD SCRAPER BLADE SCREWS

**USE GRADE 8
NUTS FOR STRENGTH**

DOME HEAD



5/8 Grade 8 Plow Screws

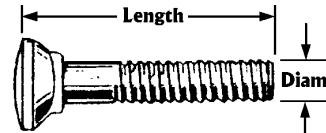

3/4 Grade 8 Plow Screws

**USE GRADE 8
NUTS FOR STRENGTH**

7/8 Grade 8 Plow Screws

Length Inches	Pkg. Qty.	Our Sequence Number	Std. Pkg. Per 100	Pkg. Qty.	Our Sequence Number	Std. Pkg. Per 100	Pkg. Qty.	Our Sequence Number	Std. Pkg. Per 100
2	25	061020	\$89.06	20	061036	\$124.89	--	----	\$....
2-1/4	25	061021	99.22	--	----	--	----
2-1/2	25	061022	108.97	20	061038	150.12	--	----
3	25	061024	125.92	20	061040	175.38	15	061052	236.96
3-1/2	25	061026	144.02	20	061042	200.91	--	----

**GRADE 5 PLOW SCREW W/Big Head
With 7/16" Diam. Shank & 1/2" Head
With 3/8" Diam. Shank & 7/16" Head
Zinc Plated
P2C5PS**

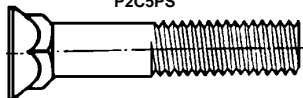

Price Per 100

Length Inches	Pkg. Qty.	Our Sequence Number	Per 100
7/16" Head 3/8" Shank - Black			
1-1/2	100	061062	\$34.09
1/2" Head 7/16" Shank			
1-3/4	50	061133	41.30
2	50	061134	57.52
2-1/4	50	0611351	43.66
2-1/2	50	061136	51.82

**GRADE 5 CLIPPED HEAD PLOW SCREWS
For Plow Shares Clipped Head**



	Size	Plow Bolts Needed
John Deere	14" & 16"	One 1/2", three 7/16"
	18"	One 1/2", four 7/16"
IHC	16" & 18"	One 1/2", three 7/16"
Oliver MM	14"	Four 7/16"
	16"	One 1/2", three 7/16"
	18" & 20"	One 1/2", four 7/16"

Length Inches	Pkg. Qty.	Our Sequence Number	PCC5PS Per 100
7/16 x 1-1/4	50	0611381	\$22.01
7/16 x 1-1/2	50	061140	25.78
1/2 x 1-1/4	50	0611412	35.32
1/2 x 1-1/2	50	061143	33.32

CONTOUR HEAD PLOW SCREW

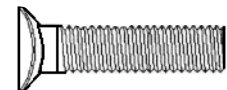

Grade 5 Plated Plow Screw

CHP5PS

Part Number & Size, Inches	Pkg. Qty.	Our Sequence Number	Per Each
3/8 x 1-1/2	100	0611371	\$21.20

Screw Qty. Disc: 5% for 5 pkgs., 7% for 10 pkgs., 10% for 25pkgs., 12% for 50 pkgs.

YANKEE HEAVY-DUTY OPAQUE BOXES

Date: 2000

Molded of polypropylene, extremely durable, chemical resistant, & withstands boiling & freezing.

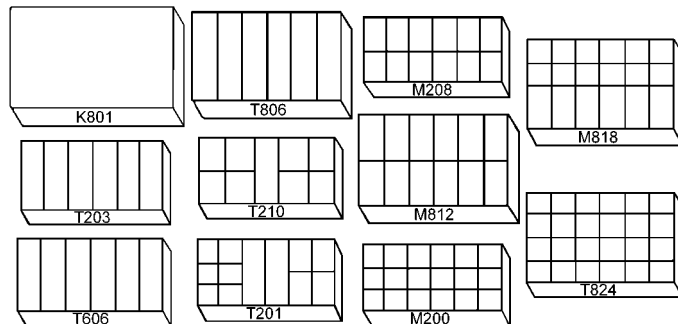

No.	No. of Compart- ments	Overall Size, Inches	Our Sequence Number	Per Each
PARTS CABINET				
K801	1	13-1/8 x 9 x 2-5/16	140368	\$19.13
T203	6	8-1/4 x 4-1/2 x 1-3/8	140356	4.81
T606	6	11 x 6-3/4 x 1-3/4	140387	7.94
T806	6	13-1/8 x 9 x 2-5/16	140370	11.87
T210	9	7 x 3-3/4 x 1-1/4	140364	3.42
T201	12	8-1/4 x 4-1/2 x 1-3/8	140358	4.81
M208	12	8-1/4 x 4-1/2 x 1-3/8	140354	4.90
M812	12	13-1/8 x 9 x 2-5/16	140375	12.09
M200	18	8-1/4 x 4-1/2 x 1-3/8	140352	4.90
M818	18	13-1/8 x 9 x 2-5/16	140380	12.09
T824	24	13-1/8 x 9 x 2-5/16	140384	11.87

A6
Date: 3300
SLOTTED HEX HEAD WASHER FACE SHEET METAL SCREWS
SHC2PS



NO Broken Packages

Price Per 100

Quantity Discount: 5% for 5 pkgs., 7% for 10 pkgs., 10% for 25 pkgs.

ORDER DIAMETER NUMBER & LENGTH IN INCHES

Length Inches	Pkg. Qty.	Our Sequence Number	Per 100
12 x 3/4	100	713830	\$7.66

SLOTTED PAN HEAD SHEET METAL SCREWS-PLATED

SPC2PS

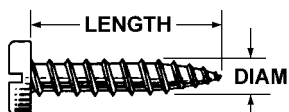

Pan Head Stocked in All Sizes.

NO Broken Packages.
Packed in Boxes of 100 Price Per 100

Slotted Pan or Binding Head-Self-Tapping
Quantity Discount: 5% for 5 pkgs., 7% for 10 pkgs., 10% for 25 pkgs.

ORDER DIAMETER NUMBER & LENGTH IN INCHES

Length Inches	Our Sequence Number	8 5/32"	Our Sequence Number	10 3/16"	Our Sequence Number	12 7/32"	Our Sequence Number	14 1/4"
1/2	620928	\$2.95*	620992	\$3.48*	621056	\$5.48	621360	\$6.37
3/4	620930	3.23*	----	621058	5.82	621376	7.05
1	620933	3.63*	621010	4.55*	621060	6.55	----
1-1/4	620935	4.65	----	621065	7.20	----
1-1/2	----	621020	5.88	621075	7.91	621840	9.69

150B Asst. One box of each starred sizes. Sequence # Z90132

TRAILER FLOOR SCREWS

TFC2BS



NO Broken Packages

Quantity Discount: 5% for 5 pkgs., 7% for 10 pkgs., 10% for 25 pkgs.

ORDER DIAMETER NUMBER & LENGTH IN INCHES

Length Inches	Pkg. Qty.	Our Sequence Number	Per 100
1/4" Torx Drive Flat Head			
1/4 x 1-1/2	100	584100	\$22.31
1/4 x 2	100	584105	28.63
1/4 x 2-1/2	100	584110	34.63

Date: 4000

TORX-HEAD BIT

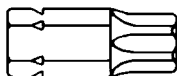

T30 Bit has Male Hex Drive

Use T-30 For Torx-Head Trailer Floor Screws

Torx Bit Number	Fits Socket Head Cap Screw	Fits Socket Set Screw	Fits Flat Head Cap Screw	Fits Pressure Plug	Our Sequence Number	Per Each
T-30	1/4	3/8	1/4	1/8	584205	\$2.91

DRILL ROD POLISHED ROUNDS CARBON STEEL DRILL RODS

Full Pkg. Date: 2500 Water-Hardening Brkn. Pkg. Date: Varies
Commercial Grade
DRILRD



Rod in 3 Foot Lengths

Carbon Content Approximately 1% Manganese .40 Silicon .20 Sulphur .040 Max. Phosphorus .040 Max.

For shafts, rollers, pins, dowel pins, push rods, and other hardened wearing parts.

Size In Inches	Approx. Weight Per 3 Ft. Length, Lbs.	Decimal Size in Ins.	Pkg. Qty.	Our Sequence Number	Per Each
3/32	.07	.0938	5	466688	\$2.87
1/8	.13	.125	5	466752	3.43
9/64	.16	.1406	5	466816	3.58
5/32	.20	.1562	5	466880	3.78
11/64	.24	.1718	5	466944	3.95
3/16	.28	.1875	5	467008	4.24
13/64	.33	.2031	5	467072	4.42
7/32	.39	.2187	5	467136	4.55
15/64	.44	.2343	5	467200	4.79
1/4	.50	.250	3	467264	4.34
17/64	.56	.2656	3	467328	5.46
9/32	.64	.2812	3	467392	6.28
19/64	.70	.2968	3	467456	6.65
5/16	.78	.3125	3	467520	6.70
21/64	.86	.3281	3	467584	8.06
11/32	.95	.3437	3	467648	8.68
3/8	1.12	.375	3	467712	8.68
13/32	1.32	.4062	3	467776	11.43
7/16	1.53	.4375	3	467840	11.55
15/32	1.75	.4687	3	467904	14.96
1/2	2.00	.500	2	467968	13.97
17/32	2.26	.5312	2	468032	17.73
9/16	2.53	.5625	2	468096	17.75
5/8	3.13	.625	2	468160	20.34
3/4	4.50	.750	2	468224	26.78
7/8	6.13	.875	2	468288	36.44
1	8.00	1.000	2	468352	47.41
1-1/16	9.03	1.0625	2	468359	61.63
1-1/8	10.13	1.125	2	468366	61.96
1-1/4	12.50	1.250	2	468373	75.31
1-3/8	15.15	1.375	2	468380	91.80
1-1/2	18.00	1.500	2	468387	107.06
1-3/4	24.51	1.750	2	468394	135.85
2	32.04	2.000	2	468401	172.96

Sold by the piece.

Tolerance In Inches

.124" and Smaller Plus or Minus .0003"
.499" to .125" Plus or Minus .0005"
1.500" to .500" Plus or Minus .001"

Hardening and Tempering

To harden, heat evenly to 1,400 to 1,450 deg. F, & quench in cold water or brine. Temper from 300 to 450 deg. F, which should result in a Rockwell hardness of 60 to 66C.

REDI-BOLT COUPLERS

Date: 4000

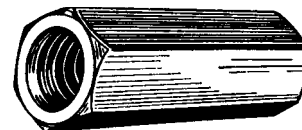

Zinc Plated Steel-Coarse 'N.C.' Threads

Used to join lengths of threaded rod end to end

Thd. Size. Inches	Lgth. Inches	Width Across Flats, Ins.	Std. Pkg	Our Sequence Number	Per 100
RBC2PCS					
SHORT LENGTHS					
1/4 ROD	7/8	3/8	50	015424	\$97.13
5/16 ROD	1	7/16	50	015486	125.53
3/8 ROD	1-1/8	1/2	50	015550	63.56
7/16 ROD	1-1/4	9/16	50	015616	110.52
1/2 ROD	1-1/4	5/8	50	015678	111.61
RBC2PCR					
LONG LENGTHS					
5/16 ROD	1-3/4	5/8	50	015488	135.36
3/8 ROD	1-3/4	5/8	50	017005	183.12
7/16 ROD	1-3/4	5/8	50	017020	191.39
1/2 ROD	1-3/4	11/16	50	017029	115.54
5/8 ROD	2-1/8	13/16	20	015744	261.98
3/4 ROD	2-1/4	1	10	015808	449.75
7/8 ROD	2-1/2	1-1/4	10	015872	851.44
1 ROD	2-3/4	1-3/8	10	015936	1080.65

Coupler Disc: 5% for 2 pkgs., 10% for 5 pkgs., 15% for 10 pkgs.

Full Pkg. Date: 3300
Brkn. Pkg. Date: Varies

GRADE 5 COARSE (N.C.) CARRIAGE SCREWS WITHOUT NUTS

Price Per 100
Sizes listed below in stock
DIAMETER, INCHES

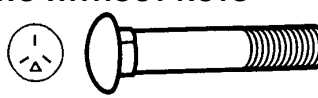
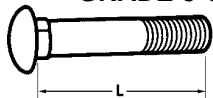

A7
SC34CAR5B Asst.
Contains 20 each
starred sizes below.
Sequence # **Z92618**

Length, Inches	Our Sequence Number	Our Sequence		Our Sequence		Our Sequence		Our Sequence		Our Sequence		
		1/4	5/16	3/8	7/16	1/2	5/8	3/4				
3/4	097700	\$15.32	\$11.01	061221	\$16.11							
1	061150	9.42	12.79	061222	22.99	061258	27.42	0612823	35.13			
1-1/4	061152	10.84	22.14	061225	20.13	061259	30.48	061283	39.48			
1-1/2	061154	11.70	16.54	061226	22.93	061260	34.62			0613001	86.00	
1-3/4				0612292	27.02	061262	36.81	061287	41.10			
2	070731	21.51	21.81	061230	37.47	061264	44.16	061288	54.44	061302	100.83	
2-1/4				061232	33.21							
2-1/2	0707315	25.90	26.26	061234	41.21	061266	52.78	061290	64.95	061304	113.80	
3			061204	30.97	061238	43.96	061268	59.44	061292	73.65	0613062	125.35
3-1/2					061240	52.68	061270	66.73	061294	98.53	061307	159.55
4					061242	58.75			061296	91.31	061308	154.44
4-1/2									061298	131.90		
5											061310	206.83
6											061312	250.86
7											061314	296.53^
8												
9											061318	413.04^
No. in Pkg.	100			50						25		20

Length, Inches	Our Sequence Number	Our Sequence		Our Sequence		Our Sequence		Our Sequence		Our Sequence			
		1/4	5/16	3/8	7/16	1/2	5/8	3/4					
3/4		\$....	0611901	\$10.18	0612211	\$14.86							
1	061151	8.80	0611921	11.50	0612232	16.94	0612582	25.31	0612822	32.26			
1-1/4	061153	10.18	0611952	13.28	0612251	18.45	0612592	28.11	0612831	36.25			
1-1/2	061155	10.94	061198	15.29	061227	21.06	0612601	31.01	061286	40.10	0613011	74.77	
1-3/4					0612294	24.91	0612621	33.84					
2			061201	20.20	0612302	27.58	061265	39.64	061289	48.50	0613021	87.52	
2-1/4					0612321	30.58							
2-1/2			061203	22.86	0612341	33.45	061267	47.32	061291	57.83	061305	101.98	
3			061205	28.67	061239	39.34	061269	54.80	061293	67.45		0613222	167.89
3-1/2					061241	47.32	061271	62.67	061295	79.84	061308	154.44	
4									061297	89.13		0613252	276.14
4-1/2									061299	125.21			
5											061311	195.07	
6											061313	230.82	
7											061315	310.40^	
8													
9											061319	384.04^	
No. in Pkg.	100			50						25		20	

^ 5 per pkg. Screw Discount: 5% for 5 pkgs., 7% for 10 pkgs., 10% for 25 pkgs. 12% for 50 pkgs.

Diameter, Inches	DIMENSIONS OF CARRIAGE SCREWS							
	1/4	5/16	3/8	7/16	1/2	5/8	3/4	
Length of Thread, Inches*								
Bolts 6 Inches & Shorter*	3/4	7/8	1	1-1/8	1-1/4	1-3/8	1-1/2	1-3/4
Bolts over 6 Inches Long	1	1-1/8	1-1/4	1-3/8	1-1/2	1-3/4	1-5/8	2
Threads to Inch N.C.(U.S.S.)	20	18	16	14	13	11	10	10
Head Diameter, Inches	9/16	11/16	13/16	15/16	1-1/16	1-5/16	1-9/16	1-9/16
Head Height, Inches	1/8	5/32	3/16	7/32	1/4	5/16	3/8	3/8
Neck Width Across Flats, Inches	17/64	21/64	25/64	29/64	33/64	41/64	49/64	49/64
Neck Height, Inches	5/32	3/16	7/32	1/4	9/32	11/32	13/32	13/32
Nut Width Across Flats, Inches	7/16	9/16	5/8	3/4	13/16	1	1-1/8	1-1/8
Nut Thickness, Inches	7/32	17/64	21/64	3/8	7/16	35/64	21/32	21/32

*Carriage Screws in lengths too short for this length of thread are threaded up to the neck.

Date: 3300

GRADE 8 HEX FLANGE SCREW - COARSE

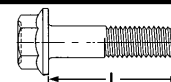

Length, Inches	Sequence #	FLC8BS								Length, Inches	
		3/8	1/2	5/8	3/4	7/8	1	1-1/8	1-1/4		
3/4	097560	\$42.92									3/4
1	097562	44.66									1
1-1/4	097564	47.06									1-1/4
1-1/2	097566	49.49	097574	84.82	097598	149.68					1-1/2
2	097570	58.06	097578	103.98	097602	207.87	097618	317.48			2
2-1/2			097582	111.19	097606	187.59	097622	375.36			2-1/2
3			097586	127.35	097610	208.18	097624	421.18			3
3-1/2							097626	466.97			3-1/2
4					097594	163.00	097614	254.44	097628	512.80	4
No. in Pkg.	100		50		25				20		Length, Inches

Diameter, Inches	DIMENSIONS OF HEX SCREWS														
	1/4	5/16	3/8	7/16	1/2	9/16	5/8	3/4	7/8	1	1-1/8	1-1/4	1-3/8	1-1/2	
Length of Thread Inches*															
Screws 6 Inches and Shorter*	3/4	7/8	1	1-1/8	1-1/4	1-3/8	1-1/2	1-3/4	2	2-1/4	2-1/2	2-3/4	3	3-1/4	
Screws over 6 Inches Long	--	--	--	--	1-1/2	1-5/8	1-3/4	2	2-1/4	2-1/2	2-3/4	3	3-1/4	3-1/2	
Threads to Inch-N.C. (U.S.S.)	20	18	16	14	13	12	11	10	9	8	7	7	6	6	
Threads to Inch-N.F. (S.A.E.)	28	24	24	20	20	18	18	16	14	14	12	12	12	12	
Width Across Flats, Inches	7/16	1/2	9/16	5/8	3/4	13/16	15/16	1-1/8	1-5/16	1-1/2	1-11/16	1-7/8	2-1/16	2-1/4	
Height of Head, Inches	5/32	13/64	15/64	9/32	5/16	23/64	25/64	15/32	35/64	39/64	11/16	25/32	27/32	15/16	

*Cap Screws too short for this length of thread are threaded up to the head.

REDI-BOLT THREADED STEEL RODS



Cut Special Bolts or Rods to Exact Length Needed
Can be Heated and Bent to Any Shape
Has Thousands of Practical Uses
In The Shop, On The Farm, In The Home

High-strength, cold-drawn steel rods threaded the full length for use in making long or irregularly-shaped bolts. Can be cut to size or used full length as straight bolts; heated and bent into U-bolts, L-bolts, eyebolts, braces and angle rods. Hard & tough, twice as strong as ordinary steel.

Coarse Thread					Coarse Thread						
3 Ft. Lengths			6 Ft. Lengths		3 Ft. Lengths			6 Ft. Lengths			
Diam. Inches	No. Per Bndl.	Our Sequence Number	Bundle Each	Our Sequence Number	Bundle Each	Our Sequence Number	Bundle Each	Our Sequence Number	Bundle Each	Wt./100 Feet	
GRADE 2 REGULAR OIL FINISH RUST-RESISTANT FINISH					GRADE 2 ZINC PLATED FINISH						
RBC2B3B					RBC2B6B					RBC2P3B	RBC2P6B
1/4	5	009920	\$1.54	010816	\$3.08	012928	\$1.85	013504	\$3.70	12	
5/16	5	009984	2.36	010880	4.72	012992	2.77	013568	5.54	20	
3/8	5	010048	2.67	010944	5.34	013056	3.08	013632	6.16	29	
7/16	5	010112	4.82	011008	9.65	013120	5.65	013696	11.29	40	
1/2	5	010176	5.03	011072	10.06	013184	5.85	013760	11.70	53	
9/16	5					013240	8.83	----	----	67	
5/8	3	010304	8.83	011136	17.66	013248	9.14	013824	18.27	84	
3/4	1	010368	12.42	011200	24.84	013312	14.06	013888	28.13	124	
7/8	1	010432	20.32	011264	40.65	013376	24.43	013952	48.86	170	
1	1	010496	26.48	011328	52.97	013440	31.82	014016	63.64	223	
1-1/8	1	010560	33.77	011392	67.54	013446	40.44	014020	80.89	281	
1-1/4	1	010624	42.08	011456	84.17	013448	50.50	014022	101.00	354	
1-3/8	1	010626	50.19	011458	100.39	----	----	----	----	425	
1-1/2	1	010752	60.66	011584	121.33	013450	72.88	014024	145.76	512	
GRADE 8 ALLOY PLATED FINISH - B7					FINE THREAD						
RBC8P3B					RBC8P6B					RBF8P3B	
1/4	5	015940	10.63	015953	21.29	015968	10.28	----	----	12	
5/16	5	015941	11.83	015954	23.66	015969	12.34	----	----	20	
3/8	5	015942	12.99	015955	26.02	015970	14.19	----	----	29	
7/16	5	015943	16.56	015957	33.12	015972	17.48	----	----	40	
1/2	5	015944	18.44	015960	40.21	015974	20.06	----	----	53	
9/16	3	0159441	23.66	0159601	47.31	015975	29.31	----	----	67	
5/8	3	015945	21.29	015961	42.58	015976	29.62	----	----	84	
3/4	1	015946	30.75	015962	61.50	015978	38.57	----	----	124	
7/8	1	015947	39.01	015963	78.06	015979	52.97	----	----	170	
1	1	015948	48.48	015964	96.99	015980	58.11	----	----	223	
1-1/8	1	015949	85.16	015965	170.32	----	----	----	----	281	
1-1/4	1	015950	108.81	015966	217.63	----	----	----	----	354	
1-1/2	1	015951	165.59	015967	331.17	----	----	----	----	512	
GRADE 8 ALLOY BLACK FINISH - B7											
RBC8B3B					RBC8B6B					RBF8B3B	
1/4	5	016098	6.17	016119	12.34	016196	11.31	016230	22.63	--	
5/16	5	016099	6.69	0161191	13.37	016198	13.58	016232	27.15	--	
3/8	5	016100	8.54	016120	17.07	016200	15.61	016234	31.22	--	
7/16	5	016102	12.34	016122	24.68	016202	19.23	016236	38.47	--	
1/2	5	016104	10.39	016124	20.78	016204	22.06	016238	44.12	--	
9/16	3	016105	17.07	016125	34.15	016205	32.24	016240	64.49	--	
5/8	3	016106	11.72	016126	23.45	016206	32.58	016242	65.16	--	
3/4	1	016108	17.07	016128	34.15	016208	42.42	016244	84.85	--	
7/8	1	016110	23.35	016130	46.69	016210	58.26	016246	116.53	--	
1	1	016112	29.62	016132	59.24	016212	63.92	016248	127.84	--	
1-1/8	1	016114	44.74	016134	89.48	016214	78.06	016250	156.12	--	
1-1/4	1	016116	52.66	016136	105.32	016216	100.69	016252	201.38	--	
1-1/2	1	016118	85.67	016138	171.35	016218	134.06	016254	268.13	--	

Date: 2000

REDI-BOLT ASSORTMENTS

Each Assortment Contains	Qty. Per Item	Plated Coarse	Qty. Per Item	Oil Finish	Qty. Per Item	Plated Coarse	Qty. Per Item	Oil Finish	Qty. Per Item	Grade 8 Coarse	Qty. Per Item	Grade 8 Coarse
		1260		1261		1262		1263		1264		1265
1/4, 5/16	20	3 Ft Lgth.96 pcs	20	3 Ft Lgth.96 pcs	10	6 Ft Lgth.51 pcs	10	6 Ft Lgth.51 pcs	--	3 Ft Lgth.21 pcs	--	6 Ft Lgth.21 pcs
3/8, 7/16	20	Sequence	20	Sequence	10	Sequence	10	Sequence	5	Sequence	5	Sequence
1/2	10	#Z90280	10	#Z90290	5	#Z90300	5	#Z90310	5	#Z90320	5	#Z90330
5/8	3	\$279.78	3	\$242.19	3	\$342.63	3	\$298.93	3	\$300.83	3	\$614.68
3/4	3		3		3		3		3		3	

RIGHT HAND ACME HEX NUTS

Not Plated-Weldable

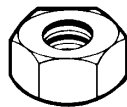

ACME RIGHT HAND THREADED ROD

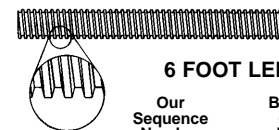

3 FOOT LENGTHS						6 FOOT LENGTHS					
Diam. Inches	Threads to Inch	Pkg. Qty.	Full Width Across Flats	Our Sequence Number	Per Each	Pkg. Qty.	Our Sequence Number	Bundle 3 Ft. Each	Our Sequence Number	Bundle 6 Ft. Each	Diam. Inches
RBA2B3						RBA2B6					
MOST COMMON THREAD PITCHES											
1/2	10	10	7/8	622910	\$5.17	1	622510	\$13.55	622560	\$27.10	1/2
5/8	8	5	1-1/16	622915	5.87	1	622515	19.37	622562	38.74	5/8
3/4	6	5	1-1/4	622920	7.97	1	622520	24.75	622564	49.51	3/4
7/8	6	5	1-7/16	622925	10.34	1	622525	34.65	622568	69.31	7/8
1	5	5	1-5/8	622930	13.03	1	622530	44.99	622570	89.98	1
1-1/8	5	3	1-13/16	622935	16.39	1	622535	60.64	622572	121.29	1-1/8
1-1/4	5	3	2	622940	18.71	1	622540	75.93	622574	151.86	1-1/4
1-1/2	4	3	2-3/8	622945	29.95	1	622542	107.06	622576	214.11	1-1/2

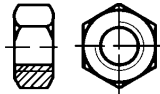

COARSE THREAD PLATED

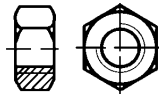

FINE THREAD PLATED

Nut Size Inches	No. In Pkg.	Thrds. To Inch	Grade 5		Grade 8		Thrds. To Inch	Grade 5		Grade 8	
			Our Sequence Number	Per 100	Our Sequence Number	Per 100		Our Sequence Number	Per 100	Our Sequence Number	Per 100
1/4	100	20	089070	\$2.15	096720	\$4.33	28	091550	\$4.60	096750	\$5.09
5/16	100	18	089072	2.34	096722	3.55	24	091552	6.63	096752	7.33
3/8	100	16	089074	5.27	096724	8.20	24	091554	8.72	096754	9.66
7/16	50	14	089076	7.98	096726	14.58	20	091556	15.49	096756	17.13
1/2	50	13	089078	12.57	096728	12.25	20	091558	18.40	096758	22.64
9/16	25	12	089080	27.04	096730	29.90	18	091560	31.78	096760	35.20
5/8	25	11	089082	20.51	096732	36.45	18	091562	38.62	096762	42.56
3/4	20	10	089084	53.72	096734	59.16	16	091564	62.69	096764	32.48
7/8	15	9	089086	85.75	096736	94.47	14	091566	100.08	096766	110.38
1	10	8	089088	127.71	096738	140.69	14	091568	149.06	096768	164.38
1-1/8	5	7	089090	167.66+	0967492	184.51+	12	096770	218.27+
1-1/4	5	7	089092	225.88+	0967494	248.62+	12	096772	151.58+
1-3/8	5	6	089094	372.43+	0967496	338.14+	12	096773	1908.19
1-1/2	5	6	089096	481.09+	0967498	530.46+	12	096774	344.13+

+Black

Date: 4000

HEAVY COARSE

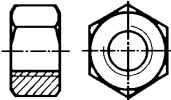

LEFT HAND HEX NUTS

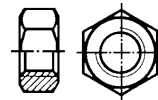

Nut Size Inches	No. In Pkg.	Coarse Thds. To Inch	Our Sequence Number	Grade 2 Plain Hex Nuts	Width Across Flats Inches	Thick-ness, Inches	Nut Size Inches	Coarse Thds. To Inch	Fine Thds. To Inch	Our Sequence Number	Coarse Thread Per 100	Our Sequence Number	Fine Thread Per 100
1/4	100	20	092100	\$7.08	1/2	15/64	1/4	20	28	231545	\$16.95	231600	\$16.95
5/16	100	18	092102	9.47	9/16	19/64	5/16	18	24	231550	28.55	231605	21.93
3/8	100	16	092104	14.65	11/16	23/64	3/8	16	24	231555	26.49	231610	27.71
7/16	50	13	092108	18.83	7/8	31/64	7/16	14	20	231560	36.82	231615	36.82
1/2		11	092110	49.09	1-1/16	39/64	1/2	13	20	231565	50.06	231620	50.06
5/8	25	11	092110	49.09	1-1/16	39/64	5/8	11	18	231570	141.27	231625	92.71
3/4	20	10	092112	82.27	1-1/4	47/64	3/4	10	16	231575	188.36	231630	145.68
7/8	15	9	092114	109.70	1-7/16	55/64	7/8	9	14	231580	237.68	231635	237.68
1	10	8	092116	188.71	1-5/8	63/64	1	8	14	231585	429.69	231640	430.43
1-1/8	5						1-1/8	7	12	231587	821.12	
1-1/4	5						1-1/4	7	12	231590	1106.60	

Quantity Discount: 5% for 5 pkgs., 7% for 10 pkgs., 10% for 25 pkgs., 22.8% for 50 pkgs.
Nuts may be mixed for Quantity except Left Hand

HEX NUT ASSORTMENTS

Date: 2000

Each Assortment Contains	GRADE 5 HEX NUT			ELASTIC STOP STANDARD NUT				
	Qty. Per Item	Grade 5 Coarse	Qty. Per Item	Coarse	Coarse Thin	Qty. Per Item	Fine Thin	
1/4, 5/16	100	6CNB	100	6CELB	100	SETC2P	100	SETF2P
3/8	100	T806 Box	100	T806 Box	100	No Box	100	No Box
7/16	50	425 pcs.	50	425 pcs.	--	395 pcs.	--	395 pcs.
1/2	50	Sequence	50	Sequence	50	Sequence	50	Sequence
5/8	25	# Z91286	25	# Z91213	25	# Z92110	25	# Z92102
3/4	--	\$32.62	--	\$66.90	20	\$91.31	20	\$91.31

Each Assort. Contains	JAM NUT				SLOTTED NUT			
	Qty. Per Item	Coarse	Qty. Per Item	Fine	Qty. Per Item	Fine Slotted	Qty. Per Item	Coarse Slotted
1/4	--	SJNC2P	--	SJNF2P	100	SSNF2P	--	SSNC2P
5/16, 3/8	100	Std.Box	100	Std. Box	100	No Box	100	No Box
7/16	50	370 pcs.	50	370 pcs.	--	395 pcs.	--	295 pcs.
1/2	50	Sequence	50	Sequence	50	Sequence	50	Sequence
5/8	25	# Z92290	25	# Z92294	25	# Z92100	25	# Z92108
3/4	20	\$66.35	20	\$82.35	20	\$171.12	20	\$119.01
7/8	15		15		--		--	
1	10		10		--		--	

OTHER NUT ASSORTMENTS ON PAGES A4 and A10

A12
No Broken Pkgs.

COTTER PINS - HAMMERLOCK AND EFFICIENCY

Date: 5000
Brkn. Pkg. Date: Varies



Steel "Efficiency" Point Extended Length is measured from under the eye to tip of point.

EFFICIENCY COTTER PINS
These pins are easy to insert, and the points are close together and well tapered. Will spread easily and hold.
PRICE PER 1000

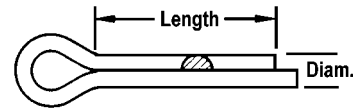

100 in a Pkg.

Diam. x Length	Our Sequence Number	Per 1000	Diam. x Length	Our Sequence Number	Per 1000	Diam. x Length	Our Sequence Number	Per 1000	Diam. x Length	Our Sequence Number	Per 1000
COTPINS											
1/16 x 1/2	598350	\$14.23	7/64 x 1-1/2	598450	\$47.43	3/16 x 1-1/4	598545	\$85.70	1/4 x 4	598635	\$430.24
1/16 x 3/4	598355	17.63	7/64 x 1-3/4	598455	53.57	3/16 x 1-1/2	598550	115.96	5/16 x 1-1/2	598640	234.59
1/16 x 1	598360	21.84	7/64 x 2	598460	60.39	3/16 x 1-3/4	598555	109.88	5/16 x 2	598645	290.37
1/16 x 1-1/4	598365	26.12	1/8 x 3/4	598465	27.39	3/16 x 2	598560	145.02	5/16 x 2-1/2	598650	399.65
1/16 x 1-1/2	598370	30.39	1/8 x 1	598470	47.29	3/16 x 2-1/2	598565	148.69	5/16 x 3	598655	480.14
5/64 x 1/2	598380	21.78	1/8 x 1-1/4	598475	55.91	3/16 x 3	598570	169.13	5/16 x 3-1/2	598660	636.05
5/64 x 1	598390	26.05	1/8 x 1-1/2	598485	56.24	3/16 x 3-1/2	598575	192.58	5/16 x 4	598665	596.10
5/64 x 1-1/4	598395	32.26	1/8 x 1-3/4	598490	53.57	3/16 x 4	598580	216.16	3/8 x 1-1/2	598670	376.54
5/64 x 1-1/2	598400	37.41	1/8 x 2	598495	83.30	1/4 x 1	598585	113.09	3/8 x 2	598675	451.29
3/32 x 1/2	598405	18.30	1/8 x 2-1/2	598500	73.48	1/4 x 1-1/4	598590	134.06	3/8 x 2-1/2	598680	625.43
3/32 x 3/4	598410	22.98	1/8 x 3	598505	86.77	1/4 x 1-1/2	598595	154.84	3/8 x 3	598685	714.67
3/32 x 1	598415	26.05	5/32 x 1	598510	53.04	1/4 x 1-3/4	598600	175.01	3/8 x 3-1/2	598690	677.33
3/32 x 1-1/4	598420	32.26	5/32 x 1-1/4	598515	76.22	1/4 x 2	598605	231.85	3/8 x 4	598695	752.41
3/32 x 1-1/2	598425	37.41	5/32 x 1-1/2	598520	86.37	1/4 x 2-1/4	598610	216.89	3/8 x 5	598700	1071.50
3/32 x 1-3/4	598430	42.35	5/32 x 2	598525	125.91	1/4 x 2-1/2	598615	272.33	1/2 x 3	598705	1917.36
3/32 x 2	598435	45.96	5/32 x 2-1/2	598530	126.05	1/4 x 2-3/4	598620	270.46	1/2 x 4	598710	2434.58
7/64 x 1	598440	47.29	5/32 x 3	598535	147.69	1/4 x 3	598625	330.65	1/2 x 6	598715	3365.67
7/64 x 1-1/4	598445	40.48	3/16 x 1	598540	73.28	1/4 x 3-1/2	598630	320.50			

Quantity Discount: 5% for 2 pkgs., 10% for 5 pkgs., 15% for 10 pkgs.



COTTER PIN ASSORTMENTS

Date: 4000

50AG Asst. -contains 50 assorted sizes from 3/32" x 3/4" thru 5/16" x 2-1/2"

100AG Asst. -contains 100 assorted sizes from 3/32" x 3/4" thru 5/16" x 2-1/2"

Ideal Asst. -contains 100 assorted sizes from 1/16" x 1/2" thru 5/32" x 1-1/2"

Part Number	Our Sequence Number	Each
50AG Cotter	602632	\$5.68
100AG Cotter	602634	8.99
Ideal Cotter	602642	2.73

Qty. Disc: 5% for 5 pkgs., 10% for 10 pkgs.

HAMMERLOCK COTTER PINS

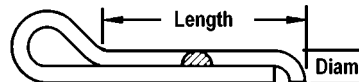

Price Per 1000

100 in a Pkg.

Diam. x Length	Our Sequence Number	Per 1000	Diam. x Length	Our Sequence Number	Per 1000	Diam. x Length	Our Sequence Number	Per 1000
HAMCOTS								
1/16 x 1/2	602808	\$14.50*	7/64 x 1	603520	\$34.92	5/32 x 1-1/2	604288	\$88.01*
1/16 x 3/4	602812	17.97*	7/64 x 1-1/2	603584	48.33	5/32 x 2	604352	110.33
1/16 x 1	602816	23.41*	1/8 x 3/4	603648	27.91	3/16 x 1	604416	74.67
1/16 x 2	602880	39.20	1/8 x 1	603712	40.16*	3/16 x 1-1/4	604480	87.33
1/16 x 2-1/2	602890	63.23	1/8 x 1-1/4	603776	47.44	3/16 x 1-1/2	604512	99.58
5/64 x 1/2	602944	21.44	1/8 x 1-1/2	603840	55.54*	3/16 x 2	604544	143.14*
5/64 x 1	603072	26.54	1/8 x 1-3/4	603904	54.59	3/16 x 2-1/2	604608	151.51
5/64 x 1-1/2	603136	38.12	1/8 x 2	603968	70.72*	3/16 x 3	604672	172.34
3/32 x 3/4	603200	26.89	1/8 x 2-1/2	604032	74.87	1/4 x 1-1/2	604736	157.77
3/32 x 1	603264	26.54*	1/8 x 3	604096	88.41	1/4 x 2	604800	228.90*
3/32 x 1-1/4	603328	32.87	5/32 x 1	604160	54.04	1/4 x 2-1/2	604864	241.29
3/32 x 1-1/2	603392	38.12	5/32 x 1-1/4	604224	65.48	1/4 x 3	604928	283.89
3/32 x 2	603456	46.83						

1000B Asst. One pkg. of 100 each starred sizes. Comes in a M812 box & label. Sequence # **Z90072**
Quantity Discount: 5% for 2 pkgs., 10% for 5 pkgs., 15% for 10 pkgs.

Date: 4000

HAIR PIN COTTERS
Cadmium Plated

Oil Tempered Spring Steel Wire



HAIR PIN COTTER ASSORTMENTS



No. 19 and 20 have 50 per Standard Pkg. & 10 in Minipak
All other numbers are 100 per Package & 20 in Minipak

Cotter Number	F Wire Diam. Inches	A Length Overall Inches	D Inside Diam. Eye, Ins.	Our Sequence Number	Price Per 100
3	3/32	1-5/8	5/16	602304	\$10.69
6	3/16	3-1/4	7/8	602496	45.77
8	3/16	3-3/4	7/8	602500	54.82
9	5/32	3-5/16	3/4	602375	31.01
10	5/32	2-15/16	3/4	602432	29.29
11	1/8	2-9/16	7/16	602368	23.57
13	3/32	1-3/16	1/4	602250	8.89
14	3/32	2-1/2	7/16	602312	16.17
16	1/8	1-3/4	7/16	602320	17.23
18	1/16	1-9/16	5/16	602245	12.37
19	1/4	4-3/8	3/4	602560	126.16
20	5/16	3-15/16	7/8	602624	231.18

Date: 2000

Each Assortment Contains	Qty. Per Item		Qty. Per Item
3, 6, 8	20	150ECHPC	--
9, 10, 11	20	T606 Box	--
13, 14	--	120 pcs.	20
16, 18	--	Sequence #	20
19, 20	--	Z92594	10
		\$39.17	
151ECHPC		T606 Box	
		100 pcs.	
		Sequence #	
		Z92592	
		\$46.26	
Each Assortment Contains	Qty. Per Item		Hair Pin No. Qty. Per Item
3, 6, 8	20	270BHPC	3 3
9, 10, 11	20	M812 Box	6 4
13, 14	20	220 pcs.	10 4
16, 18	20	Sequence #	11 4
19, 20	10	Z92588	
		\$81.63	
		HPC-15	
		15 pcs.	
		Sequence #	
		602629	
		\$7.40	



NO BROKEN PACKAGES

FLAT WASHERS

Bolt Size Ins.	Approx. No. in 5 Lb.	Our Sequence Number	Grade 2			Grade 5			Grade 8			Approximate Dimensions		
			5 Lb. Price Per 100 Lb.	Pkg. Qty.	Our Sequence Number	Price Per 1000 pcs.	Pkg. Qty.	Our Sequence Number	Price Per 1000 pcs.	Our Sequence Number	Price Per 1000 pcs.	O.D. Inches	Hole Size Inches	Thick-ness Inches
3/16	1810	534000	\$471.46	100	534100	\$13.07	100	534150	\$3.69	534256	\$39.84	9/16	1/4	3/64
1/4	745	534005	\$379.58	100	534102	\$25.47	100	534155	\$79.36	534258	\$66.21	3/4	5/16	1/16
5/16	450	534010	\$484.73	100	534104	\$55.73	100	534160	\$98.95	534260	\$85.56	7/8	3/8	5/64
3/8	335	534015	\$507.25	100	534106	\$75.71	100	534165	\$156.33	534265	\$124.11	1	7/16	5/64
7/16	205	534020	\$507.65	100	534108	\$120.93	100	534170	\$264.34	534270	\$264.34	1-1/4	1/2	5/64
1/2	130	534025	\$482.80	100	534110	\$185.69	100	534272	\$220.66	534275	\$538.93	1-3/8	9/16	7/64
9/16	110	534030	\$365.09	50	534112	\$165.94	25	534175	\$538.93	534280	\$71.24	1-1/2	5/8	7/64
5/8	65	534035	\$482.80	50	534114	\$371.37	25	534180	\$71.24	534285	\$623.63	1-3/4	11/16	9/64
3/4	45	534040	\$482.80	50	534116	\$530.57	20	534185	\$990.49	534290	\$891.19	2	13/16	5/32
7/8	32	534045	\$482.80	50	534118	\$742.79	15	534190	\$1216.99	534290	\$891.19	2-1/4	15/16	11/64
1	26	534050	\$482.80	50	534120	\$910.93	10	534190	\$1216.99	534290	\$891.19	2-1/2	1-1/16	11/64
1-1/8	22	534055	\$457.96+	25	534122	\$1017.69+	-----	-----	-----	-----	-----	2-3/4	1-1/4	11/64
1-1/4	19	534060	\$457.96+	25	534124	\$1205.14+	-----	-----	-----	-----	-----	3	1-3/8	11/64
1-3/8	15	534065	\$342.29+	25	534126	\$1140.97+	-----	-----	-----	-----	-----	3-1/4	1-1/2	3/16
1-1/2	13	534070	\$457.96+	25	534128	\$1761.38+	-----	-----	-----	-----	-----	4	1-5/8	3/16
1-3/4	10	534080	\$493.40+	10	534130	\$2467.00+	-----	-----	-----	-----	-----	4-1/2	1-7/8	3/16
2	7	534085	\$493.40+	10	534132	\$3122.77+	-----	-----	-----	-----	-----	5	2-1/8	3/16
2-1/2	5	534090	\$529.08+	10	534134	\$5087.26+	-----	-----	-----	-----	-----	5	2-5/8	15/64

+ Black



LOCK WASHERS

SAE IN GRADE 5 & GRADE 8 FLAT WASHERS

Bolt Size	Pkg. Qty.	Our Sequence Number	Grade 5 Zinc Plated			Grade 8 Gold Plated			Grade 5			Grade 8			Approx. Dimen.		
			Price Per 1000 pcs.	Pkg. Qty.	Our Sequence Number	Price Per 1000 pcs.	Width Ins. x	Thick-ness Ins.	Pkg. Qty.	Our Sequence Number	Price Per 1000 Pieces	Our Sequence Number	Price Per 1000 Pieces	O.D. Inches	Size Inches	Thick-ness Inches	
5/32	-----	-----	\$....	-----	-----	\$....	.055 x .040	100	092342	\$4.40	-----	\$....	7/16	3/16	3/64		
3/16	-----	-----	\$....	-----	-----	\$....	.062 x .047	100	092346	\$4.79	-----	\$....	1/2	7/32	3/64		
1/4	100	533160	\$32.76	100	533360	\$31.55	.109 x .062	100	534200	\$30.46	534220	\$29.01	5/8	9/32	1/16		
5/16	100	533162	\$51.37	100	533362	\$60.03	.125 x .078	100	534202	\$38.62	534222	\$38.15	11/16	11/32	1/16		
3/8	100	533166	\$87.48	100	533364	\$72.87	.141 x .094	100	534204	\$48.35	534224	\$48.35	13/16	13/32	1/16		
7/16	100	533170	\$86.59	100	533366	\$164.50	.156 x .109	100	534206	\$60.44	534226	\$60.44	59/64	15/32	1/16		
1/2	100	533172	\$100.39	100	533368	\$156.10	.171 x .125	100	534208	\$158.88	534228	\$158.88	1-1/16	17/32	3/32		
9/16	40	533174	\$91.66	25	533369	\$178.19	.188 x .141	-----	-----	-----	-----	-----	-----	-----	-----		
5/8	40	533178	\$237.28	25	533370	\$364.55	.203 x .156	25	534210	\$289.23	534230	\$209.79	1-5/16	11/16	3/32		
3/4	40	533180	\$391.89	20	533372	\$506.75	.234 x .188	20	534212	\$283.34	534232	\$333.11	1-1/2	13/16	9/64		
7/8	40	533182	\$571.06	15	533374	\$953.30	.266 x .219	15	534214	\$399.71	534234	\$399.71	1-3/4	15/16	9/64		
1	40	533184	\$553.98	10	533376	\$875.93	.297 x .250	10	534216	\$453.21	534236	\$453.21	2	1-1/8	9/64		
1-1/8	10	533190	\$969.42+	-----	-----	\$....	.328 x .281	-----	-----	-----	-----	-----	-----	-----	-----		
1-1/4	10	533192	\$1412.05+	-----	-----	\$....	.359 x .312	-----	-----	-----	-----	-----	-----	-----	-----		
1-3/8	10	533194	\$1267.07+	-----	-----	\$....	.391 x .344	100	1/2 391-3784-027	974240	\$0.97	1-1/4	33/64	3/16			
1-1/2	10	533196	\$1785.93+	-----	-----	\$....	.422 x .375	50	9/16 391-3782-146	974217	\$0.83	1-3/16	19/32	3/16			
-----	-----	-----	-----	-----	-----	-----	-----	50	5/8 391-3784-028	974245	\$0.33	1-1/4	21/32	3/16			

+ Black

Washer Discount: 5% for 5 pkgs., 7% for 10 pkgs., 10% for 25 pkgs.
Sizes and types can be combined for quantity discount.

Commercial Discount ONLY 100 pkgs. 7.5% only

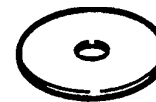

FENDER WASHERS ZINC PLATED

ORDER BY BOLT SIZE

A light gauge steel washer with a large outside diameter used principally for fender and body repair work, wood construction and assembly.

Sold in 100 PIECE PACKAGE

Bolt Size Inches	Our Sequence Number	Pkg. Price Per 1000	Outside Diameter, Inches	Hole Size, Inches	Thick-ness Inches	Bolt Size Inches	Our Sequence Number	Pkg. Price Per 1000	Outside Diameter, Inches	Hole Size, Inches	Thick-ness Inches
1/4	535160	\$59.66	1-1/4	9/32	1/16	1/4	535170	\$104.36	1-1/2	9/32	1/16
5/16	535162	\$55.93	1-1/4	11/32	1/16	5/16	535172	\$102.52	1-1/2	11/32	1/16
3/8	535164	\$55.93	1-1/4	13/32	1/16	3/8	535174	\$74.22	1-1/2	13/32	1/16
1/2	-----	-----	-----	-----	1/2	535176	\$219.05	2	15/32	1/16

Date: 2000

FLAT, SAE and LOCK WASHER STANDARD PAK ASSORTMENTS

Each Assortment Contains	Qty. Per Item	Std. Pack	Qty. Per Item	Std. Pack	Qty. Per Item	Std. Pack	Each Assortment Contains	Qty. Per Item	Std. Pack	Qty. Per Item	Std. Pack	Qty. Per Item	Std. Pack
GRADE 5 FLAT			GRADE 5 SAE			GRADE 5 LOCK							
1/4, 5/16, 3/8	100	SFW5P	100	SPFW5P	100	SSW5P	1/4, 5/16, 3/8	100	SLW5P				
7/16, 1/2	100	570 pcs	100	600 pcs.	100	570 pcs.	7/16, 1/2	100	700 pcs				
5/8	25	Sequence	100	Sequence	25	Sequence	9/16, 5/8	40	Sequence				
3/4	20	# Z92338	--	# Z92340	20	# Z92344	3/4, 7/8, 1	40	# Z92390				
7/8	15	\$86.27	--	\$86.52	15	\$41.49			\$77.03				
1	10		--		10								
GRADE 8 FLAT			GRADE 8 SAE			GRADE 2 FLAT							
1/4, 5/16, 3/8	100	SFW8P	100	SPFW8P	100	SSW8P	1/4, 5/16, 3/8	100	SFW2P	5 lbs.	BFW2P	5 lbs.	BPFW2P
7/16, 1/2	100	570 pcs	100	600 pcs.	100	570 pcs.	7/16, 1/2	100	750 pcs	5 lbs.	50 lbs.	5 lbs.	30 lbs.
5/8	25	Sequence	100	Sequence	25	Sequence	9/16	50	Sequence	5 lbs.	Sequence	--	Sequence
3/4	20	# Z92346	--	# Z92348	20	# Z92350	5/8	50	# Z92354	5 lbs.	# Z92378	5 lbs.	# Z92380
7/8	15	\$74.79	--	\$81.08	15	\$40.65	3/4, 7/8, 1	50	\$127.92	5 lbs.	\$165.92	--	\$106.66
1	10		--		10								



SOCKET HEAD SET SCREWS

METRIC SET SCREWS LISTED ON PAGE A25



Cup Point - Alloy Steel - Heat Treated
Packed in Boxes of 100 Price Per 100

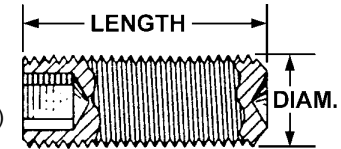

COARSE THREAD SOCKET HEAD SET SCREWS - (SSC8BS) DIAMETER, INCHES

Length Inches	Our Sequence Number	No. 8 5/32	Our Sequence Number	No. 10 3/16	Our Sequence Number	1/4	Our Sequence Number	5/16	Our Sequence Number	3/8	Our Sequence Number	7/16	Length Inches
3/16	087400	\$7.54	087410	\$7.99	087422	\$9.16							3/16
1/4	087402	7.67	087412	5.69	087424	8.22	087442	12.19					1/4
5/16	087404	7.81	087414	8.26	087426	8.35	087444	11.06	087462	15.12			5/16
3/8	087406	7.99	087416	8.49	087428	8.76	087446	11.15	087464	14.76	087480	32.05	3/8
7/16											087482	32.73	7/16
1/2	087408	8.85	087418	8.94	087430	11.51	087448	12.55	087466	17.65	087484	33.18	1/2
5/8					087432	13.86	087450	16.03	087468	21.31			5/8
3/4					087434	15.03	087452	18.69	087470	23.97	087486	40.18	3/4
1					087436	20.31	087454	24.01	087472	34.31	087488	51.23	1
1-1/4					087438	26.18	087456	32.05	087474	39.36	087490	61.84	1-1/4
1-1/2					087440	33.40	087458	42.43	087476	55.07	087492	88.93	1-1/2
2							087460	55.52	087478	69.97			2
No. in Pkg.				20						10			

COARSE THREAD (Cont'd) SOCKET HEAD SET SCREWS - (SSC8BS) DIAMETER, INCHES

Length Inches	Our Sequence Number	1/2	Our Sequence Number	5/8	Our Sequence Number	3/4	Our Sequence Number	7/8	Our Sequence Number	1	Length Inches
3/8	087494	\$33.86									3/8
1/2	087496	33.86									1/2
5/8	087498	38.37	087514	81.71							5/8
3/4	087500	41.08	087516	90.73	087530	134.52					3/4
7/8							087544	252.79			7/8
1	087502	51.91	087518	99.76	087532	144.45	087546	279.87	087550	406.27	1
1-1/4	087504	63.20	087520	135.87	087534	178.31					1-1/4
1-1/2	087506	72.23	087522	148.96	087536	189.14					1-1/2
2	087508	99.76	087524	218.93	087538	297.93			087552	686.14	2
2-1/2	087510	153.48	087526	246.92	087540	325.24			087554	835.11	2-1/2
3	087512	173.79	087528	285.29	087542	367.90					3
# in Pkg.	20	10	5					2			

FINE THREAD SOCKET HEAD SET SCREWS - (SSF8BS) DIAMETER, INCHES

Length Inches	Our Sequence Number	No. 8 5/32	Our Sequence Number	No. 10 3/16	Our Sequence Number	1/4	Our Sequence Number	5/16	Our Sequence Number	3/8	Our Sequence Number	7/16	Our Sequence Number	1/2	Our Sequence Number	5/8
3/16			087568	\$7.99	087572	\$9.16										
1/4	087566	8.35	087570	8.04	087574	8.22	087580	13.09								
5/16							087582	11.74								
3/8					087576	8.76	087584	11.96	087590	15.21						
1/2					087578	11.51	087586	13.09	087592	17.65	087596	36.56	087597	36.56		
5/8													087598	38.82	087600	91.64
3/4							087588	19.41	087594	23.97			087598	42.43		
1													087599	53.72		
No. in Pkg.								20							10	

Socket Head Set Screw Discount: 5% for 5 pkgs., 7% for 10 pkgs., 10% for 25 pkgs., 15% for 50 pkgs.

Date: 2000



SOCKET HEAD SET SCREW ASSORTMENTS

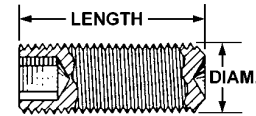

Each Assortment Contains	Qty. Per Item	Coarse	Fine	Qty. Per Item	Coarse	Fine	Qty. Per Item	Coarse	Fine	Qty. Per Item	Best Seller
8x1/4	20	MPSSSC	MPSSSF	40	SPSSSC	SPSSSF	20	BSSSC	BSSSF	40	
10x1/4	20	T201 Box	T201 Box	40	M812 Box	M812 Box	20	M812 Box	M812 Box	40	
1/4x1/4, 3/8, 1/2	20	240 pcs.	240 pcs.	40	480 pcs.	480 pcs.	40	420 pcs.	420 pcs.	40	
5/16x5/16, 3/8, 1/2	20	Sequence #	Sequence #	40	Sequence #	Sequence #	40	Sequence #	Sequence #	40	
3/8x3/8, 1/2, 3/4	20	Z92138	Z92140	40	Z92146	Z92148	40	Z92142	Z92144	40	18B
1/2x1/2 (Coarse Assts)	20	\$33.54	\$35.36	40	\$69.37	\$73.02	20	\$61.14	\$63.40	40	M818
1/2x5/8 (Fine Assts)	20			40			20			--	Box
8x1/4 C & F	20	MPSSCF		40	SPSSCF		20	BSSCF		20*	600
10x1/4 C & F	20	T201 Box		40	M812 Box		20	M812 Box		20*	pcs.
1/4x1/4 C & F	20	240 pcs.		40	480 pcs.		40	360 pcs.		20*	
5/16x3/8 C & F	20	Sequence #		40	Sequence #		40	Sequence #		20*	\$82.77
3/8x3/8 C & F	20	Z92150		40	Z92154		40	Z92152		20*	Seq. #
1/2x1/2 Coarse	20	\$34.43		40	\$71.15		20	\$53.29		--	Z91110
1/2x5/8 Fine	20			40			20			20*	

*Fine thread - rest coarse

WRENCH SIZES FOR SOCKET HEAD SET SCREWS

Screw Size	No. 8	No. 10	1/4	5/16	3/8	7/16	1/2	5/8	3/4	7/8	1&1-1/8	1-1/4&1-3/8	1-1/2
Wrench Size	5/64	3/32	1/8	5/32	3/16	7/32	1/4	5/16	3/8	1/2	9/16	5/8	3/4

THREAD SIZES FOR SOCKET HEAD SET SCREWS

Screw Size	No. 8	No. 10	1/4	5/16	3/8	7/16	1/2	5/8	3/4	7/8	1&1-1/8	1-1/4&1-3/8	1-1/2
Thread to Inch													
Coarse	32	24	20	18	16	14	13	11	10	9	8	11	10
Fine	36	32	28	24	24	20	20	18	16	14	14	18	16

HELICOIL THREAD REPAIR KITS and EXTRA PARTS
Helicoil taps are a special thread count for Helicoil use only



Helicoil Thread Repair Kit

Repair Kits contain one tap, one tool, and one package of inserts for that size.

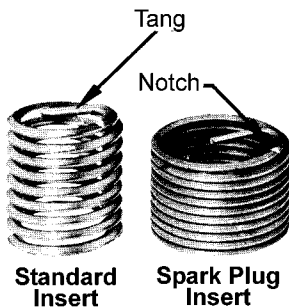

Standard Insert **Spark Plug Insert**

Helicoil Thread Repair Inserts are precision formed thread liners made of coiled 18-8 stainless steel wire. When installed into Helicoil tapped holes, they permanently conform to the size of the original thread.



Standard Type Tool

The standard Helicoil tool is used for installing Inch Coarse and Metric Coarse sizes.

No Broken Pkgs.

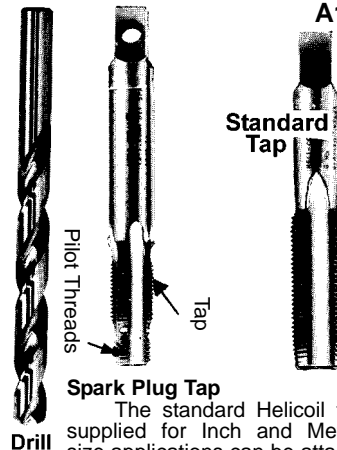

Drill

Spark Plug Tap

The standard Helicoil tap supplied for Inch and Metric size applications can be attached to a tap handle and used like a conventional tap.

Spark Plug taps feature pilot threads and tap combinations. No drilling of worn out threads is required.

Helicoil Diameter x Length Inch	Extra Helicoil Insert Part Number	No. in Pkg.	Our Sequence Number	Per Each	Helicoil Diameter x Length Inch	Extra Helicoil Insert Part Number	No. in Pkg.	Our Sequence Number	Per Each
Long Length Inch Coarse Extra Insert					Long Length Inch Fine Extra Inserts				
HLEXINSC					HLEXINSF				
8-32x.328	1185-2CN 0328	12	769610	\$0.67	10-32x.380	1191-3CN 0380	12	769640	\$....
10-24x.380	1185-3CN 0380	12	769612	0.67					0.67
12-24x.432	1185-1CN 0432	12	769614	0.67				
1/4-20x.500	1185-4CN 0500	12	769616	0.67	1/4-28x.500	1191-4CN 0500	12	769642	0.67
5/16-18x.625	1185-5CN 0625	12	769618	0.97	5/16-24x.625	1191-5CN 0625	12	769644	0.97
3/8-16x.750	1185-6CN 0750	12	769620	1.39	3/8-24x.750	1191-6CN 0750	12	769646	1.39
7/16-14x.875	1185-7CN 0875	6	769622	1.61	7/16-20x.875	1191-7CN 0875	6	769648	1.63
1/2-13x1.000	1185-8CN 1000	6	769624	2.22	1/2-20x1.000	1191-8CN 1000	6	769650	2.20
9/16-12x1.125	-----	--	----	9/16-18x1.125	1191-9CN 1125	6	769652	3.18
5/8-11x1.250	1185-10CN 1250	6	769628	4.13	5/8-18x1.250	1191-10CN 1250	6	769654	4.13
3/4-10x1.500	1185-12CN 1500	4	769630	5.75	3/4-16x1.500	1191-12CN 1500	4	769656	5.75
7/8-9x1.750	1185-14CN 1750	1	769632	7.77	7/8-14x1.750	1191-14CN 1750	1	769658	7.77
1-8x2.000	1185-16CN 2000	1	769634	10.03	1-12x2.000	1191-16CN 2000	1	769660	10.03

Helicoil Diameter x Length Inch	Repair Kit Part Number	Our Sequence Number	Per Each Kit	Extra Helicoil Insert Part Number	No. in Pkg.	Our Sequence Number	Per Each	Use Drill Size
Inch Coarse Thread Repair Kits-Contain one tap, one tool, and one pkg. of inserts for each size								
HLREPKITC				HLEXREPKITC				
8-32x.246	5521-2	769582	\$43.42	1185-2CN 0246	12	769454	\$0.64	11/64
10-24x.285	5521-3	769584	40.75	1185-3CN 0285	12	769456	0.64	13/64
12-24x.324	5521-1	769580	43.42	1185-1CN 0324	12	769458	0.64	15/64
1/4-20x.375*	5521-4	769586	31.83	1185-4CN 0375	12	769460	0.64	17/64
5/16-18x.469*	5521-5	769588	31.51	1185-5CN 0469	12	769465	0.77	21/64
3/8-16x.562*	5521-6	769590	31.83	1185-6CN 0562	12	769470	1.03	25/64
7/16-14x.656*	5521-7	769592	34.30	1185-7CN 0656	6	769475	1.20	29/64
1/2-13x.750*	5521-8	769594	41.24	1185-8CN 0750	6	769480	1.63	17/32
9/16-12x.844	5521-9	769596	73.50	1185-9CN 0844	6	769485	2.52	19/32
5/8-11x.938*	5521-10	769598	72.77	1185-10CN 0938	6	769490	3.22	21/32
3/4-10x1.125	5521-12	769600	92.59	1185-12CN 1125	4	769495	4.66	25/32

NOTE: The following 2 Kits come complete with High Speed Steel Drill for 1/2" Chucks.

7/8-9x1.312	5521-14	769602	218.29	1185-14CN 1312	1	769500	6.32	29/32
1-8x1.500	5521-16	769604	277.82	1185-16CN 1500	1	769505	8.27	1-1/32

*Also Included in Master Thread Repair Kit - Part Number 5522

Helicoil Diameter x Length Inch	Repair Kit Part Number	Our Sequence Number	Per Each	Extra Helicoil Insert Part Number	No. in Pkg.	Our Sequence Number	Per Each	Use Drill Size
Inch Fine Thread Repair Kits-Contain one tap, one tool, and one pkg. of inserts for each size								
HLREPKITF				HLEXREPKITF				
10-32x.285+	5528-3	769700	50.23	1191-3CN 0285	12	769515	0.64	13/64
1/4-28x.375+	5528-4	769702	50.23	1191-4CN 0375	12	769520	0.64	17/64
5/16-24x.469+	5528-5	769704	50.23	1191-5CN 0469	12	769525	0.77	21/64
3/8-24x.562+	5528-6	769706	50.23	1191-6CN 0562	12	769530	1.03	25/64
7/16-20x.656+	5528-7	769708	50.23	1191-7CN 0656	6	769535	1.20	29/64
1/2-20x.750+	5528-8	769710	55.78	1191-8CN 0750	6	769540	1.61	33/64
9/16-18x.844	5528-9	769712	83.50	1191-9CN 0844	6	769545	2.52	37/64
5/8-18x.938	5528-10	769714	83.50	1191-10CN 0938	6	769550	3.22	41/64
3/4-16x1.125	5528-12	769716	103.58	1191-12CN 1125	4	769555	4.66	49/64

NOTE: The following 3 Kits come complete with High Speed Steel Drill for 1/2" Chucks

7/8-14x1.312	5528-14	769718	274.90	1191-14CN 1312	1	769560	6.32	57/64
1-14x1.500	5528-16	769719	322.57	1191-16CN 1500	1	769565	8.27	1-1/64
1-12x1.500	5528-161	769720	322.57	1191-161CN 2000	1	769660	10.03	

*Also Included in Master Thread Repair Kit - Part Number 5526

Spark Plug Metric Repair Kit								
Helicoil Diameter x Length Inch	HLSPMM	Our Sequence Number	Per Each	HLSPINMM	No. in Pkg.	Our Sequence Number	Per Each	Use Drill Size
M14x1.25x3/8	5523-14*	769740	196.07	512	6	769440	1.00	None
M14x1.25x1/2	5523-14*	769740	196.07	513-13	6	769442	1.51	None
M14x1.25x3/4	5523-14*	769740	196.07	513-10	6	769444	2.32	None

*Spark Plug Metric Kit: Contains special tap, insertion tool, and six each M14 x 1.25 x 3/8, 7/16, 1/2, 3/4, and .472 inserts.

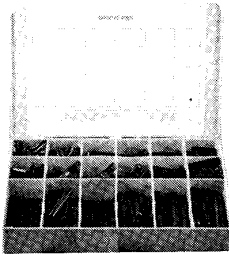

**520B ASSORTMENT
M818 BOX**

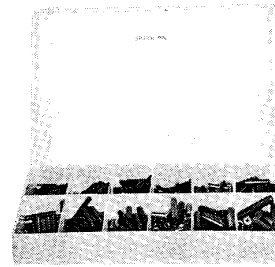

**120B ASSORTMENT
M812 BOX**

ROLL PINS

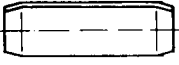
Each Assortment Contains	Qty. Per Item		Each Assortment Contains	Qty. Per Item		Qty. Per Item	
1/8x3/4, 1, 1-1/2	10	120B M812 box 120 pcs. Sequence # Z90004 \$39.18					
3/16x1, 1-1/4	10						
1/4x1-1/4, 1-1/2, 2	10						
5/16x1-1/2, 2	10						
3/8x1-1/2, 2	10						
1/16x3/4	10	123ECRP T203 box 120 pcs. Sequence # Z90003 \$20.30	1/16x3/4, 5/64x3/4	10	240B T824 box 240 pcs. Sequence # Z90006 \$54.27	20	
5/64x3/4	10		3/32x5/8, 1, 1-1/4	10		20	480B Two M812 boxes 480 pcs. Sequence # Z90016 \$87.31
3/32x1	10		1/8x3/4, 1, 1-1/2	10		20	
1/8x1, 1-1/2	10		5/32x1, 7/32x2	10		20	
5/32x1	10		3/16x3/4, 1, 1-1/4	10		20	
		1-1/2, 2, 2-1/2					
3/16x1, 1-1/2	10		1/4x1-1/4, 1-1/2, 2, 2-1/2	10		20	
7/32x2	10		5/16x1-1/2, 2	10		20	
1/4x1-1/4, 1-1/2, 2	10		3/8x1-1/2, 2	10		20	
1/4x1, 1-1/2, 2	10	124ECRP T606 box 120 pcs. Sequence # Z90005 \$62.12	1/16x3/4, 1, 5/64x3/4	10	520B Three M818 boxes 540 pcs. Sequence # Z90050 \$143.31		
5/16x1-1/2, 2	10		3/32x5/8, 3/4, 1, 1-1/4	10			
3/8x1-1/2, 2, 2-1/2	10		1/8x3/4, 1, 1-1/4, 1-1/2, 1-3/4, 2	10			
7/16x1-1/2, 2	10		5/32x3/4, 1, 1-1/4, 1-1/2, 2	10			
1/2x1-1/2, 2	10		3/16x3/4, 1, 1-1/4, 1-1/2,	10			
		1-3/4, 2, 2-1/2					
			7/32x1-1/2, 2	10			
			1/4x1, 1-1/4, 1-1/2, 1-3/4, 2	10			
			2-1/4, 2-1/2, 3				
			5/16x1, 1-1/2, 1-3/4, 2	10			
			2-1/4, 2-1/2, 3				
			3/8x1, 1-1/2, 1-3/4, 2, 2-1/2, 3	10			
			7/16x1-1/2, 2, 3	10			
			1/2, 1-1/2, 2, 3	10			

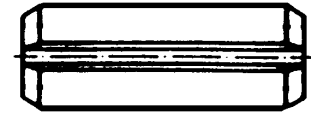

WOODRUFF KEYS

Each Assortment Contains	Qty. Per Item		Qty. Per Item		Qty. Per Item		Qty. Per Item
3, 9, A	10	ECMPWK T203 box 60 pcs. Sequence # Z92602 \$54.18	10	RPWK M812 box 120 pcs. Sequence # Z92600 \$76.61	10	1800B M818 box 180 pcs. Sequence # Z90102 \$108.70	10
15, 18, D	10		10		10		10
5, 6, 6I	--		10		10		10
13, B, C	--		10		10		10
7, 8, 9I	--		--		--		--
11, 21, E	--				10	SPWK T824 box 220 pcs. Sequence # Z92598 \$154.16	10
16, 14I	--				10		
23, G	--				10		
					10		
					10		

SQUARE KEYSTOCK

Each Assortment Contains	Qty. Per Item	
1/8 x 12	5	25 ASSORTMENT K801 box 25 pcs. Sequence # Z90060 \$75.65
3/16 x 12	5	
1/4 x 12	5	
5/16 x 12	5	
3/8 x 12	5	

MACHINERY BUSHINGS

Each Assortment Contains	Qty. Per Item		Qty. Per Item		Qty. Per Item		Qty. Per Item	
NARROW RIM								
9/16x18, 5/8x18, 3/4x18, 1x18	10	60ECNRB T203 Box 60 pcs. Sequence # Z92616 \$12.57 Less 7/8x14	10	230B T824 Box 230 pcs. Sequence # Z90112 \$77.73	10	250 MACH BUSHING No box 250 pcs. Sequence # Z90110 \$72.79	10	
7/8x18, 1-1/8x18, 1-1/4x18	--		10		10		10	
1-1/8x14, 1-1/4x14, 1-3/8x14	--		10		10		10	
3/4x14, 7/8x14, 1x14	10		--		--		--	
3/4x10, 1x10	--		10		10		10	
1-1/8x10, 1-1/4x10	--				10	240NRWRMB T824 Box 240 pcs. Sequence # Z92614 \$83.19		
WIDE RIM								
3/4x18, 7/8x18, 1x18	--				10			
1-1/8x18, 1-1/4x18, 1-3/8x18	--				--			
1-1/2x18, 1-1/2x14	--				--			
3/4x14, 7/8x14, 1x14	--				10			

SLOTTED PAN HEAD SHEET METAL SCREW

Each Assortment Contains	Qty. Per Item	
8x1/2	100	150B T806 Box 600 pcs. Sequence # Z90132 \$26.74
8x3/4	100	
8x1	100	
10x1/2	100	
10x3/4	100	
10x1	100	

SET COLLARS

Each Assortment Contains	Qty. Per Item	
LSC 8, 10, 20	2	27 No Box 27 pcs. Sequence # Z91018 \$177.48
LSC 12, 14	4	
LSC 16	5	
LSC 18	3	
LSC 15, 19	1	
LSC 22, 23, 24	1	

A20 STOVE SCREWS / SLOTTED ROUND HEAD MACHINE SCREWS LESS NUTS

DRILL SCREWS Zinc Plated

Full Pkg. Date: 3300
Brkn. Pkg. Date: Varies

NO Broken Packages



Coarse-RMC2PS
Fine-RMF2PS
**Slotted Head-Less Hex Nuts
Plated Finish
Coarse (N.C.) Threads and Fine (N.F.) Threads*
Price Per 100 Less Nuts**

Machine Screw & Machine Screw Nut Quantity Discount: 5% for 5 pkgs., 7% for 10 pkgs., 10% for 25 pkgs. Pkg. Qty. 100

Size x Length	Our Sequence Number	Per Pkg.	Size x Inches	Our Sequence Number	Per Pkg.
8-32x1/2	616640	\$2.12	1/4x1-1/4	618048	\$6.18
8-32x3/4	616704	2.40	1/4x2	618240	8.43
8-32x1-1/2	616770	4.52	1/4x2-1/2	618368	10.77
10-24x1-1/4	617152	3.69	1/4x3	618432	11.42
10-24x2-1/2	617472	8.18	5/16x1	618752	10.86
10-24x3	617536	9.01	5/16x1-1/2	618816	13.63
10-32x1-1/4	617684	4.00	5/16x2	618818	14.58

All Coarse Thread except 10-32 Fine Thread

FLAT HEAD MACHINE SCREWS

Coarse-FMC2PS



**82 Degree Countersunk
Coarse (N.C.) Threads
Slotted Heads-Less Hex Nuts Plated Finish
Price Per 100 Less Nuts**

Machine Screw & Machine Screw Nut Quantity Discount: 5% for 5 pkgs., 7% for 10 pkgs., 10% for 25 pkgs.

Lgth. Inches	Our Sequence Number	Diameter, Inches		Our Sequence Number	Our Sequence Number	Our Sequence Number	Our Sequence Number
		#10-24 3/16	1/4				
1/2		\$....	613760 \$4.31				
3/4	613248	2.86	613888 4.95	614720	10.12	615360	16.49
1	613312	3.29	614784	11.14
1-1/4	613376	3.75	614016 6.37	614848	12.95
1-1/2	613440	4.43	614080 7.11	614912	14.00
2	615680	22.40
2-1/2	614336 11.05
Threads to Inch		24	20	18		16	

Date: 2500

**SQUARE HEAD SET SCREWS (SQC8BS)
PRICE PER 100**

Length Inches	1/4	5/16	3/8	7/16	1/2	5/8	3/4
1/2	087612 \$12.19	087622 \$17.15	087634 \$21.67	\$....	\$....	\$....	\$....
3/4	087614 12.64	087624 17.60	087636 22.34		087652 50.11		
1	087616 13.99	087626 19.41	087638 25.50	087646 42.43	087654 51.91	087666 102.47	
1-1/4	087618 15.35	087628 21.22	087640 28.66		087656 57.33		
1-1/2	087620 16.70	087630 22.80	087642 31.37	087648 50.11	087658 63.20	087668 121.43	
2	087632 30.70	087644 37.92	087650 59.59	087660 77.64	087670 134.97	087676 230.67
2-1/2	087662 89.83	087672 151.67	087678 262.72
3	087664 102.92	087674 204.04	087680 297.93
No. in Pkg.		20			10		5
Head Width Ins.	1/4	5/16	3/8	7/16	1/2	5/8	3/4
Head Height Ins.	3/16	15/64	9/32	21/64	3/8	15/32	9/16

Square Head Set Screw Discount: 5% for 5 pkgs., 7% for 10 pkgs., 10% for 25 pkgs., 15% for 50 pkgs.

Date: 2000

SQUARE HEAD SET SCREW ASSORTMENTS

Each Assortment Contains	Qty. Per Item	Coarse	Qty. Per Item	Coarse
1/4 x 3/4, 1	20	MPSHSSC	40	SPSHSSC
5/16 X 1/2, 3/4, 1	20	T201 Box	40	M812 Box
3/8 x 3/4, 1, 1-1/4, 1-1/2	20	240 pcs.	40	480 pcs.
7/16 x 1	20	Sequence # Z92156	40	Sequence # Z92158
1/2 x 1, 1-1/2	20	\$65.15	40	\$132.78

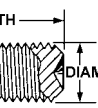

Cup Point - Case Hardened
Length is measured from under head to extreme point
Length of Thread - Square Head Set Screws are Threaded right up to the head.
When ordering, specify diameter first and then length.

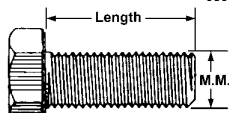

Short lengths are full thread
Din. 933 Coarse Din. 961 Fine
ISO 4017 Coarse & Fine

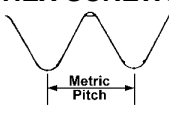

Metric Pitch is
Distance Between
Threads in M.M.

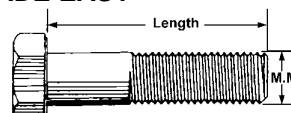

Long lengths are partial thread
Din. 931 Coarse Din. 960 Fine
ISO 4014 Coarse & Fine

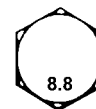

Price Per 100	M6 x1.00 Coarse Grade 8 Black Class 10.9	M6 x1.00 Coarse Grade 5 Plated Class 8.8	M8 x1.25 Coarse Grade 8 Black Class 10.9	M8 x1.25 Coarse Grade 5 Plated Class 8.8	M8 x1.00 Fine Grade 5 Black Class 8.8
Head Marked					
Diam./Inch Approximate	1/4	1/4	5/16	5/16	5/16
Diam./Inch Exact	.2362	.2362	.3150	.3150	.3150
Threads per Inch	25-1/2	25-1/2	20	20	25-1/2
Compare Thread With	3/8 Fine	3/8 Fine	1/4 Coarse	1/4 Coarse	3/8 Fine
Width Across Flats M.M.	10	10	13	13	13
Head Height M.M.	4	4	5.5	5.5	5.5
Fully Threaded up to & Including Length M.M.	25	25	30	30	30
Thread Length for Partly Threaded Up to 125 MM Over 125 MM	18 --	18 --	22 28	22 28	22 --

Length M.M.	Inch Approx.	Our Sequence Number	MHSC8BM	Our Sequence Number	MHSC5PM	Our Sequence Number	MHSC8BM	Our Sequence Number	MHSC5PM	Our Sequence Number	MHSF5BM	Length M.M.
10	3/8		\$....	225610	\$15.33		\$....	225715	\$25.84		\$....	10
12	1/2	225100	10.27	225615	14.73		225720	27.31		12
16	5/8	225105	11.87	225625	15.53	225160	33.97	225730	18.32		16
20	3/4	225110	22.20	225630	10.68	225165	25.12	225735	18.81	226665	35.07	20
25	1	225115	23.05	225635	11.41	225170	26.57	225740	20.87	226670	37.41	25
30	1-3/16	225120	21.60	225638	17.78	225175	29.49	225745	24.63	226675	38.60	30
35	1-3/8	225125	23.30*	225646	16.02	225180	37.37		226680	44.35	35
40	1-9/16	225130	25.12*	225651	23.37	225185	41.74	225756	30.82	226685	51.69	40
45	1-3/4	225135	29.12*	225656	16.27	225190	48.90	225761	32.88	226690	58.48*	45
50	2	225140	32.15*	225660	21.72	225195	51.93	225765	35.92	226695	53.30*	50
55	2-3/16		225200	54.48	225770	37.74		55
60	2-3/8	225145	41.86	225671	29.28	225205	55.33	225775	40.41	226700	66.75*	60
65	2-9/16		225675	36.04		65
70	2-3/4	225150	54.86	225681	37.37	225215	63.46	225785	48.05	226705	85.05*	70
75	3		225685	35.19	225217	139.05	225790	54.84		75
80	3-3/16	225154	60.56	225691	41.25	225220	70.25	225795	56.06	226710	92.46*	80
90	3-1/2		225805	26.39*		90
100	4		225700	79.23*		225810	72.44*		100
110	4-3/8		225815	100.71*		110
120	4-3/4		225820	154.41*		120
150	6		225830	201.91+		150
No. In Pkg.	Unstarred *Starred +Cross		20 *4		20 *5		10		20 *5 +2		10 *5	

Price Per 100	M10 x1.50 Coarse Grade 8 Black Class 10.9	M10 x1.50 Coarse Grade 5 Plated Class 8.8	M10 x1.25 Fine Grade 5 Black Class 8.8	M10 x1.00 Ex. Fine Grade 5 Black Class 8.8	M12 x1.75 Coarse Grade 8 Black Class 10.9	M12 x1.75 Coarse Grade 5 Plated Class 8.8
Head Marked						
Diam./Inch Approximate	3/8	3/8	3/8	3/8	1/2	1/2
Diam./Inch Exact	.3937	.3937	.3937	.3937	.4724	.4724
Threads per Inch	17	17	20	25-1/2	14-1/2	14-1/2
Compare Thread With	3/8 Coarse	3/8 Coarse	1/4 Coarse	3/8 Fine	7/16 Coarse	7/16 Coarse
Width Across Flats M.M.	17 or 16	17 or 16	17 or 16	17 or 16	19 or 18	19 or 18
Head Height M.M.	7	7	7	7	8	8
Fully Threaded up to & Including Length M.M.	35	35	35	35	40	40
Thread Length for Partly Threaded Up to 125 MM Over 125 MM	26 32	26 32	26 32	26 32	30 36	30 36

Length M.M.	Inch Approx.	Our Sequence Number	MHSC8BM	Our Sequence Number	MHSC5PM	Our Sequence Number	MHSF5BM	Our Sequence Number	MHSX5BM	Our Sequence Number	MHSC8BM	Our Sequence Number	MHSC5PM
10	3/8		\$....	225840	\$130.07		\$....		\$....		\$....	\$....	
16	5/8	225225	73.05	225856	37.95		225975	57.27	57.27	
20	3/4	225230	42.47	225861	40.92	226728	18.73		225981	52.78	52.78	
25	1	225235	43.07	225865	37.61	226730	56.60	227235	56.40	225986	99.53	99.53	
30	1-3/16	225240	46.72	225870	40.41	226735	61.60	227240	57.96*	225310	74.02	225990	61.91
35	1-3/8	225245	50.23*	225876	49.07	226740	189.84*	227245	75.71	225315	76.81	225995	62.73
40	1-9/16	225250	59.82*	225878	52.47	226745	34.99*	227250	86.88*	225320	79.48	226001	92.08
45	1-3/4	225255	65.52*	225885	54.97		225325	88.09	226006	211.44
50	2	225260	68.19*	225890	57.15	226755	106.29*		225330	94.76	226010	55.17
55	2-3/16	225265	87.81*	225893	57.88		227261	112.84*	
60	2-3/8	225270	82.75*	225901	117.14	226765	127.16*		225340	103.87	226021	182.67
65	2-9/16	225272	225905	85.49		226025	43.07*
70	2-3/4	225275	94.64*	225911	87.07	226775	115.04*	227264	122.31*	225350	117.70*
75	3	225280	132.02*	225915	87.87		226035	118.55*
80	3-3/16	225282	100.71*	225920	91.12	226785	144.99*	227266	101.21*	225360	50.11*	226041	122.93*
90	3-1/2		225926	98.84		225365	155.07*	226045	132.14*
100	4	225290	143.77*	225931	108.72	226795	188.65*		225370	164.78*	226051	144.76*
110	4-3/8		225936	138.33*		225375	201.54*	226056	181.75*
120	4-3/4		225941	146.94*		226061	183.34*
130	5		225945	181.16*		226066	229.81*
140	5-1/2		225948	206.40*	
150	6	225295	271.17	225951	241.46*	
160	6-1/4		226080	418.25+
200	8		225965	470.43*	
No. In Pkg.	Unstarred *Starred +Cross		10 *5		10 *2		10 *5		10 *5		5 *2		10 *5 +1

NO Broken Pkg. Quantity Discounts: 15% for 5 pkgs., 20% for 10 pkgs., 30% for 25 pkgs. Can mix sizes and types.

METRIC HEX NUTS

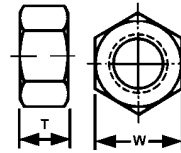
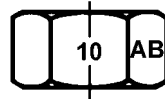
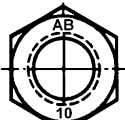
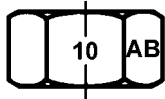

Price Per 100

COARSE

Class 8
Grade 5

Class 10
Grade 8

FINE

Watch for marking on nut to indicate class

EXTRA FINE

Inch Approx.	Part Number	No. In Pkg.	Our Sequence Number	Coarse Grade 8 Black Class 10		Coarse Grade 5 Plated Class 8		Class 10 Grade 8			Fine Grade 5 Plated Class 8			Part Number	No. In Pkg.	Our Sequence Number	Ex. Fine Grade 5 Plated Class 8	W Width Across Flats M.M.	T Thickness M.M.
				MNTC8BM	Our Sequence Number	MNTC5PM	Our Sequence Number	Part Number	No. In Pkg.	Our Sequence Number	MNTF5PM	Part Number	No. In Pkg.						
1/4	M6x1.00	20	227386	\$5.12	227425	\$7.07	-----	--	-----	---	---	---	---	---	---	---	---	10	5
5/16	M8x1.25	20	227388	9.95	227440	11.93	M8x1.00	20	227570	15.36	-----	---	---	---	---	---	---	13	6.5
3/8	M10x1.50	20	227390	36.19	227455	21.67	M10x1.25	20	227580	25.62	-----	---	---	---	---	---	---	17-16	8
1/2	M12x1.75	20	227392	59.49	227470	25.65	M12x1.50	10	227590	34.17	M12x1.25	20	227680	32.45	-----	---	---	19-18	10
9/16	M14x2.00	20	227394	79.04	227485	38.45	M14x1.50	10	227600	60.67	-----	---	---	---	---	---	---	22-21	11
5/8	M16x2.00	10	227396	89.41	227500	40.91	-----	---	-----	---	-----	---	-----	---	---	---	---	24	13
11/16	M18x2.50	5	-----	---	227510	109.31	-----	---	-----	---	-----	---	-----	---	---	---	---	27	15
3/4	M20x2.50	5	227398	276.86	227525	134.72	-----	---	-----	---	-----	---	-----	---	---	---	---	30	16
7/8	M22x2.50	5	-----	---	227535	142.87	-----	---	-----	---	-----	---	-----	---	---	---	---	32	13
1	M24x3.00	5	227400	452.80	227550	220.25	-----	---	-----	---	-----	---	-----	---	---	---	---	36	19

NO Broken Pkg.

Nut Qty. Disc: 15% for 5 pkgs., 20% for 10 pkgs., 30% for 25 pkgs.

GRADE 5 METRIC NUT ASSORTMENT

Assorts. Date: 2000

Assortment Contains	Qty. Per Item	
M6, M8, M10, M12 Nut	100	5MCNB
M16 Nut	50	T806 Box & Label
M20 Nut	25	475 pcs.
Sequence Number Z91666		\$87.66

**PROMPT WAREHOUSE SERVICE
SAME DAY SHIPMENT**

METRIC THREADED ROD Coarse Grade 2 Plated - Class 4.6



No Broken Packages
1 Per Pkg.

1 Meter in Length (39 inches)

M2NC Assortment is one piece each size threaded rod listed below
Our Sequence Number Z97430 **\$329.50**

Inch Approx.	Part Number	Our Sequence Number	Per Each
1/4	M6x1.00	016380	\$8.94
5/16	M8x1.25	016382	15.08
3/8	M10x1.50	016384	21.68
1/2	M12x1.75	016386	29.68
9/16	M14x2.00	016388	39.60
5/8	M16x2.00	016390	61.73
11/16	M18x2.50	016392	54.76
3/4	M20x2.50	016394	74.48
1	M24x3.00	016396	133.38

Threaded Rod Qty. Disc: 7% for 2 pkgs., 10% for 5 pkgs. 15% for 10 pkgs.

METRIC BOLT and NUT GAGE

Part No.	Our Sequence #	Each GAGE
MG/4	000102	\$4.33

METRIC HEX SOCKET SET SCREWS



Date: 2500

Pkg Qty: 10

PRICE PER 100

Part Number Diam.xLgthxPitch	Our Sequence Number	Per Each	Part Number Diam.xLgthxPitch	Our Sequence Number	Per Each
M3x3x.50	088010	\$22.65	M5x6x.80	088036	\$25.26
M3x4x.50	088012	22.65	M5x8x.80	088038	25.26
M3x5x.50	088014	22.96	M5x10x.80	088040	26.59
M3x6x.50	088016	22.96	M5x12x.80	088042	28.19
M3x8x.50	088018	23.62	M6x6x1.00	088044	25.26
M3x10x.50	088020	25.26	M6x8x1.00	088046	25.26
M4x5x.70	088024	23.62	M6x10x1.00	088048	26.59
M4x6x.70	088026	23.62	M6x12x1.00	088050	28.19
M4x8x.70	088028	25.26	M8x8x1.25	088052	31.02
M4x10x.70	088030	25.26	M8x10x1.25	088054	31.02
M4x12x.70	088032	28.19	M8x12x1.25	088056	32.89
M5x5x.80	088034	23.62	M10x10x1.50	088058	34.04
			M10x12x1.50	088060	44.45

26B Assortment: 1 pkg of 10 of each size above Z91111 **\$70.58**

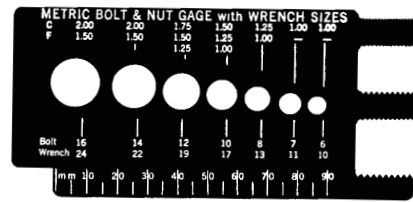

METRIC HELICAL SPRING LOCK WASHERS

Date: 4000

Zinc Plated Spring Steel Heat Treated

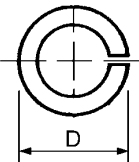

20 per pkg.

MLKW5PM

For Screw Size M.M.	Inch Approx.	Our Sequence Number	Price Per 100	D Outside Diam. M.M.	T Thickness M.M.
M4	5/32	227796	\$5.28	7.6	0.9
M5	3/16	227798	4.70	9.2	1.2
M6	1/4	227800	5.66	11.8	1.6
M8	5/16	227810	5.51	14.8	2.0
M10	3/8	227820	11.64	18.1	2.2
M12	1/2	227830	14.06	21.1	2.5
M14	9/16	227840	19.38	24.1	3.0
M16	5/8	227850	21.77	27.4	3.5
M18	11/16	227860	18.30	29.4	3.5
M20	3/4	227870	39.91	33.6	4.0
M22	7/8	227880	44.81	35.9	4.0
M24	1	227890	69.08	40.0	5.0

Washer Qty. Disc: 15% or 5 pkgs., 20% for 10 pkgs., 30% for 25 pkgs.

METRIC FLAT WASHERS

Date: 4000

Cold Rolled Steel Zinc Plated

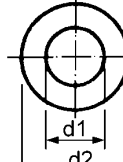
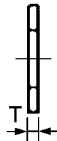

20 per pkg.

MFLW2PM

For Screw Size M.M.	Inch Approx.	Our Sequence Number	Price Per 100	d1 Hole Size M.M.	d2 Outside Diam. M.M.	T Thickness M.M.
M4	5/32	227690	\$1.26	4.3	9.0	0.8
M6	1/4	227700	6.09	6.4	12.5	1.6
M8	5/16	227710	5.89	8.4	17.0	1.6
M10	3/8	227720	12.06	10.5	21.0	2.0
M12	1/2	227730	14.41	13.0	24.0	2.5
M14	9/16	227740	20.57	15.0	28.0	2.5
M16	5/8	227750	24.77	17.0	30.0	3.0
M18	11/16	227760	32.06	19.0	34.0	3.0
M20	3/4	227770	30.09	21.0	37.0	3.0
M24	1	227790	82.99	25.0	44.0	4.0

METRIC HEX SCREW, NUT & WASHER ASSORTMENT IN BOX
 ADHESIVE LABEL 8-1/2" X 11" size to stick inside lid,
 Shows **PART NUMBER, SIZE, QUANTITY, & WHERE** to put each item in box.

These Assortments contain **ONLY** the **BEST SELLERS** Minipack and Starter Pack packed in a yellow polypropylene crush proof box 9" wide x 13-1/2" long x 2-5/16" high. Thread Pitch Below Part Numbers

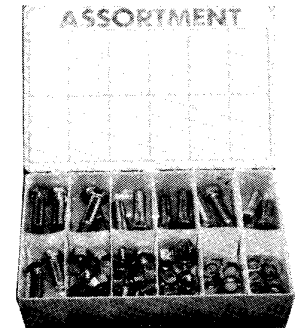
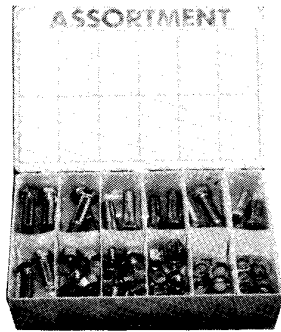

Minipack with Box
 Approx. One-Fifth Standard Pack

Standard Pack

Starter Pack with Box

Each Assortment Contains	Qty. Per Item	Grade 5 Coarse	Qty. Per Item	Grade 5 Coarse	Grade 8 Coarse	Grade 5 Fine*	Qty. Per Item	Grade 5 Coarse	Each Assortment Contains	Qty. Per Item	Grade 5 Coarse	Grade 8 Coarse
M6x16, 20, 25, 30 M6x35, 40, 50 M6x12, 45, 60 M6x10, 55, 65, 70 M6x75, 80, 100 Hex Nuts Ovalok Nuts Stop Nuts Flat Washers Lock Washers	2 2 2 2 2 50 50 50 50 50	MM6C5 1.00 284 pcs. Sequence #Z91504 \$47.98	100 100 -- -- -- 100 100 100 100 100	SM6C5 1.00 1200 pcs. Sequence #Z91558 \$89.40	SM6C8 1.00 1200 pcs. Sequence #Z91578 \$118.74	None	2 2 -- -- -- 10 10 10 10 10	BM6C5 1.00 64 pcs. Sequence #Z91612 \$18.29	M16x40,45,50,60 M16x70, 80 M16x90 Hex Nuts Ovalok Nuts Stop Nuts Flat Washers Lock Washers	25 10 10 50 50 50 100 100	SM16C5 2.00 455 pcs. Sequence #Z91568 \$233.76	SM16C8 2.00 480 pcs. Sequence #Z91588 \$255.49
M8x16, 20, 25, 30 M8x40, 50, 60 Hex Nuts Ovalok Nuts Stop Nuts Flat Washers Lock Washers		None	100 100 100 100 100 100 100	SM8C5 1.25 1200 pcs. Sequence #Z91560 \$144.63	SM8C8 1.25 1200 pcs. Sequence #Z91580 \$186.87	SM8F5 1.00 1100 pcs. Sequence #Z91594 \$219.43	2 2 10 10 10 10 10	BM8C5 1.25 64 pcs. Sequence #Z91614 \$20.91	M18x40, 45, 50 M18x60,80,90 Hex Nuts Ovalok Nuts Stop Nuts Flat Washers Lock Washers	25 10 25 25 25 100 100	SM18C5 2.50 380 pcs. Sequence #Z91570 \$300.72	None
SM8F5 minus M8x16												
M10x20, 25, 30, 35 M10x45, 55, 80 Hex Nuts Ovalok Nuts Stop Nuts Flat Washers Lock Washers		None	50 50 100 100 100 100 100	SM10C5 1.50 800 pcs. Sequence #Z91562 \$145.53	SM10C8 1.50 850 pcs. Sequence #Z91582 \$201.86	SM10F5 1.25 800 pcs. Sequence #Z91596 \$230.85	2 2 10 10 10 10 10	BM10C5 1.50 62 pcs. Sequence #Z91616 \$27.41	M20x40,45,50,60 M20x70, 80, 90 Hex Nuts Ovalok Nuts Stop Nuts Flat Washers Lock Washers	10 10 25 25 25 100 100	SM20C5 2.50 345 pcs. Sequence #Z91572 \$236.89	SM20C8 2.50 345 pcs. Sequence #Z91590 \$236.09
SM10C5 & BM10C5 minus M10x55 SM10F5 minus M10x45, 55												
M12x30, 35, 40, 50, 60 M12x70, 80 Hex Nuts Ovalok Nuts Stop Nuts Flat Washers Lock Washers		None	50 25 100 100 100 100 100	SM12C5 1.75 800 pcs. Sequence #Z91564 \$334.64	SM12C8 1.75 800 pcs. Sequence #Z91584 \$369.23	SM12F5 1.25 750 pcs. Sequence #Z91598 \$190.23	2 2 10 10 10 10 10	BM12C5 1.75 64 pcs. Sequence #Z91618 \$54.00	M22x50, 60 x40,45,55,70,90 Hex Nuts Ovalok Nuts Stop Nuts Flat Washers Lock Washers	10 10 25 25 25 100 100	SM22C5 2.50 345 pcs. Sequence #Z91574 \$416.32	None
SM12F5 minus M12x70, 80												
M14x30, 40, 50, 60 M14x70, 80, 90 Hex Nuts Ovalok Nuts Stop Nuts Flat Washers Lock Washers		None	25 25 100 50 50 100 100	SM14C5 2.00 575 pcs. Sequence #Z91566 \$306.38	SM14C8 2.00 525 pcs. Sequence #Z91586 \$357.34	SM14F5+ 1.50 500 pcs. Sequence #Z91600 \$192.71		None	M24x50, 60, 80 M24x100 Hex Nuts Ovalok Nuts Stop Nuts Flat Washers Lock Washers	10 5 25 25 25 100 100	SM24C5 3.00 310 pcs. Sequence #Z91576 \$430.09	SM24C8 3.00 310 pcs. Sequence #Z91592 \$542.05
SM14F5 minus M14x70, 80, 90 SM14C8 minus M14x60, 80												

+M14 Assortments do not have elastic stop nuts in fine thread.

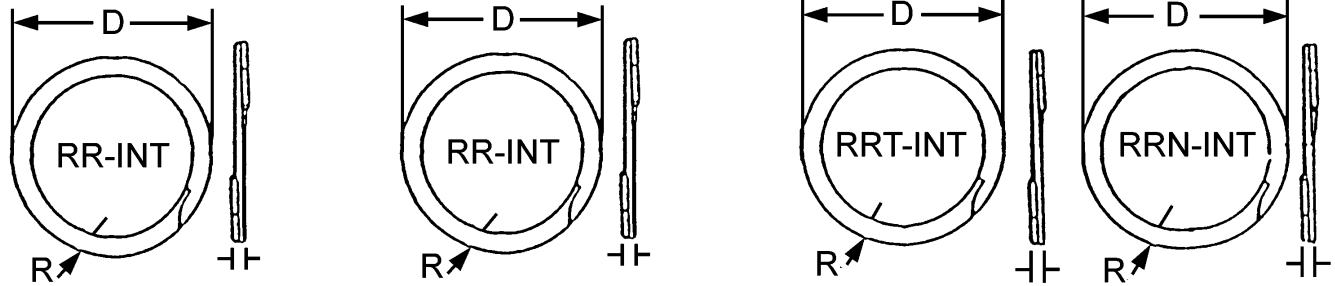

INTERNAL SNAP RINGS

Diameter Inches				RR-INT MEDIUM				RRT-INT MED. HEAVY				RRN-INT HEAVY						
Fraction	Ring Decimal	Size Dash Number	Pkg. Qty.	D Free Diam. Inches	R Radial Wall Inches	Our Sequence Number	Per Each	D Free Diam. Inches	R Radial Wall Inches	Our Sequence Number	Per Each	D Free Diam. Inches	R Radial Wall Inches	Our Sequence Number	Per Each			
							SRSIRR								SRSIRT			
1/2	.500	-50	25	.532	.045	536602	\$0.89	.529	.045	536730	\$0.76	.538	.045	536860	\$0.76			
5/8	.625	-62	25	.658	.045	536606	0.89	--	--	--	--	--	--			
3/4	.750	-75	25	.790	.065	536610	0.89	--	--	--807	.065	536868	0.83			
13/16	.812	-81	16	--	--	--	--	--	--873	.075	536870	2.42			
7/8	.875	-87	16	.922	.065	536614	0.95	.929	.065	536742	0.89	.943	.085	536872	2.48			
1	1.000	-100	12	1.054	.075	536618	0.95	1.063	.075	536746	0.89	--	--	--			
1-1/8	1.125	-112	10	1.180	.075	536622	0.95	1.195	.078	536750	1.02	1.205	.103	536880	2.54			
1-1/4	1.250	-125	8	1.312	.085	536626	1.02	--	--	--	--	--	--			
1-3/8	1.375	-137	8	1.442	.095	536630	1.14	1.461	.098	536758	1.08	--	--	--			
1-7/16	1.437	-143	8	--	--	--	--	--	--	1.539	.118	536890	2.61			
1-5/8	1.625	-162	6	--	--	--	--	--	--	1.742	.128	536896	2.67			
1-7/8	1.875	-187	4	--	--	--	--	--	--	2.008	.158	536904	2.73			
2	2.000	-200	4	2.091	.128	CA0015	2.91	--	--	--	--	--	--			
3	3.000	-300	2	--	--	--	3.188	.188	CA0025	6.17	--	--	--			
3-1/2	3.500	-350	1	3.636	.188	CA0027	4.51	--	--	--	--	--	--			
3-7/8	3.875	-387	1	4.025	.208	536686	5.21	--	--	--	4.136	.312	536940	11.95			
4	4.000	-400	1	--	--	--	4.248	.250	CA0055	11.10	--	--	--			
4-1/2	4.500	-450	1	4.674	.238	CA0060	6.50	--	--	--	--	--	--			
4-3/4	4.750	-475	1	--	--	--	--	--	--	5.030	.312	536948	16.72			
5-1/2	5.500	-550	1	5.693	.250	CA0120	6.98	--	--	--	--	--	--			

Quantity Discounts: 2 pkgs 5%, 5 pkgs 10%, 10 pkgs 20%

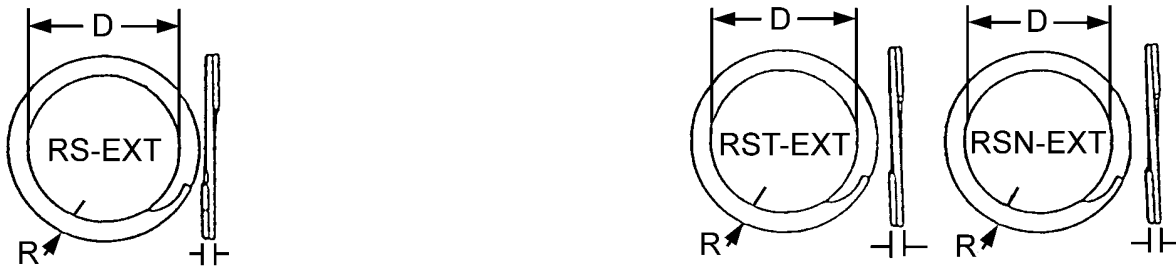

EXTERNAL SNAP RINGS

Diameter Inches				RS-EXT MEDIUM				RST-EXT MED. HEAVY				RSN-EXT HEAVY						
Fraction	Ring Decimal	Size Dash Number	Pkg. Qty.	D Free Diam. Inches	R Radial Wall Inches	Our Sequence Number	Per Each	D Free Diam. Inches	R Radial Wall Inches	Our Sequence Number	Per Each	D Free Diam. Inches	R Radial Wall Inches	Our Sequence Number	Per Each			
							SRSERS								SRSEST			
1/2	.500	-50	25	.467	.045	536988	\$0.95	.469	.045	537104	\$0.83	.464	.050	537220	\$0.83			
5/8	.625	-62	25	.585	.055	536992	1.02	--	--	--583	.055	537224	0.89			
7/8	.875	-87	16	.828	.065	537000	1.08	.827	.075	537116	1.02	--	--	--			
15/16	.938	-93	14	.889	.065	537002	1.08	.886	.075	537118	1.02	--	--	--			
1	1.000	-100	12	.946	.075	537004	1.14	--	--	--	--	--	--			
1-1/8	1.125	-112	10	1.070	.075	537008	1.21	1.064	.088	537124	1.08	--	--	--			
1-3/8	1.375	-137	8	1.308	.095	537016	1.33	--	--	--	1.277	.118	537248	2.67			
1-5/8	1.625	-162	6	--	--	--	--	--	--	--	--	--			
1-13/16	1.813	-181	4	--	--	--	--	--	--	--	--	--			
3-3/4	3.750	-375	1	3.606	.198	537064	4.96	--	--	--	--	--	--			
4	4.000	-400	1	3.842	.218	537068	6.17	--	--	--	--	--	--			